



MODEL 2852-DPM Dry Pump Monitor

User Manual

Technical Support
Continental North America Toll Free 1-(800) 387-9487
Ph: +1 (905) 829-2418 Fx: +1 (905) 829-4701



A Product of Arjay Engineering Ltd.
Oakville, Ontario, Canada

www.ArjayEng.com

<i>MODEL:</i>	
<i>HARDWARE NO.:</i>	5.1
<i>SOFTWARE NO.:</i>	
<i>SERIAL NO.:</i>	

2852-DPM Dry Pump Monitor



Pipe monitoring for dry conditions to protect pumps and equipment

Over 40 years of capacitance experience stands behind the 2852-DPM pipe monitor. The unique in-line sensor continuously monitors for the change from a wet to dry condition or a liquid change from one dielectric to another.

- capacitance technology responds to any liquid type
- no moving parts
- remote alarm unit mounts safely away from pipe
- no intrusion into stream flow

The 2852-DPM sensor monitors a cross sectional area of the pipe and locks in on the capacitance field of the fluid passing through. A change toward a dry condition or a liquid of a different dielectric will upset the capacitive field and initiate an alarm.

The sensing plates are embedded into a wafer flange which provides monitoring without any intrusion into the stream flow.

up to 1 km
optional alarm light and/or buzzer

Optional Intrinsically Safe Sensor

PVC sensing flange (150# Ansi configuration)

Remote Electronics available in painted steel, SS or polycarbonate enclosure

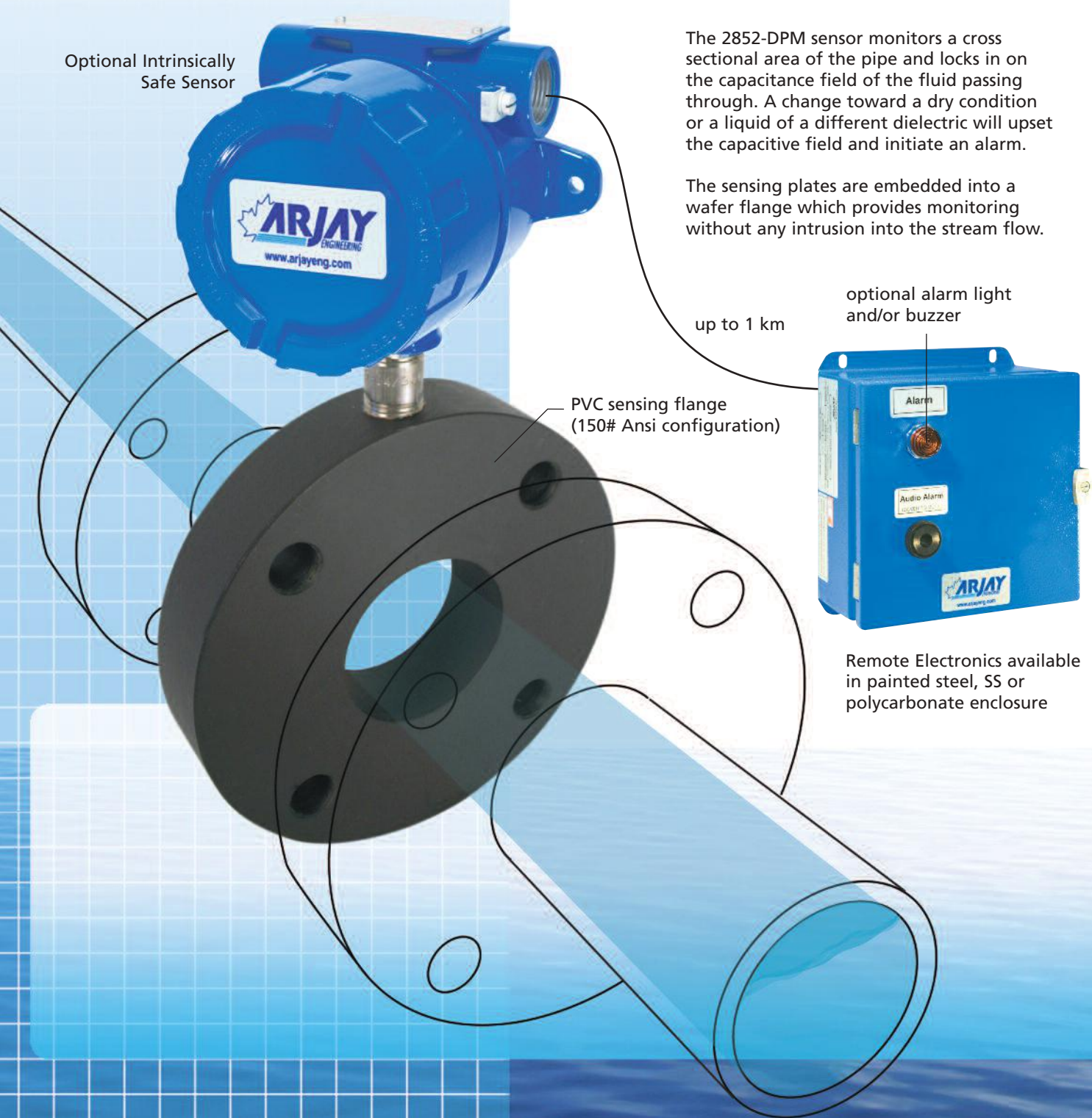

2852-DPM

Features and Benefits

- wafer flange sensor for easy installation
- adjustable time delay and sensitivity to eliminate nuisance alarms from bubbles
- remote electronics via standard twisted pair
- Sensor available Intrinsically Safe for Hazardous Locations
- PVC wetted parts for corrosive environments
- capacitance technology responds to all types of liquids
- non-intrusive sensor design does not restrict flow

Technical Specifications - Control Unit

Operating Temp.	-20°C to 55°C
Resolution	.007% (.07 pF at 1,000 pF)
Accuracy	.04% of full scale pF
Power Input	12 vdc or 24 vdc or 100-240 vac +/- 10%
Alarm Relay	2 x 10 amp@240 vac, SPDT, dry
Analog Output	4 mA normal/20 mA alarm
Communication	Modbus RS-485
Certified	UL 61010-1, 2 nd Edition CAN/CSA-22.2 61010-1-4 IEC/EN 61010-1, 2 nd Edition IEC 61326-1 CE Declared
Enclosure	Type 4/IP 66 painted steel or Type 4X/IP 66 polycarbonate or SS
Optional	Light, buzzer, beacon

Technical Specifications - Sensor

Operating Temp.	-60°C to +55°C
Intrinsic Safety	CSA Intrinsically Safe when ordered with Approved Barrier in Control Unit Div 1, Class I, Groups A,B,C,D; Class II, Groups E,F,G; Class III, Encl.Type 4
Wetted Parts	PVC (optional PVDF)

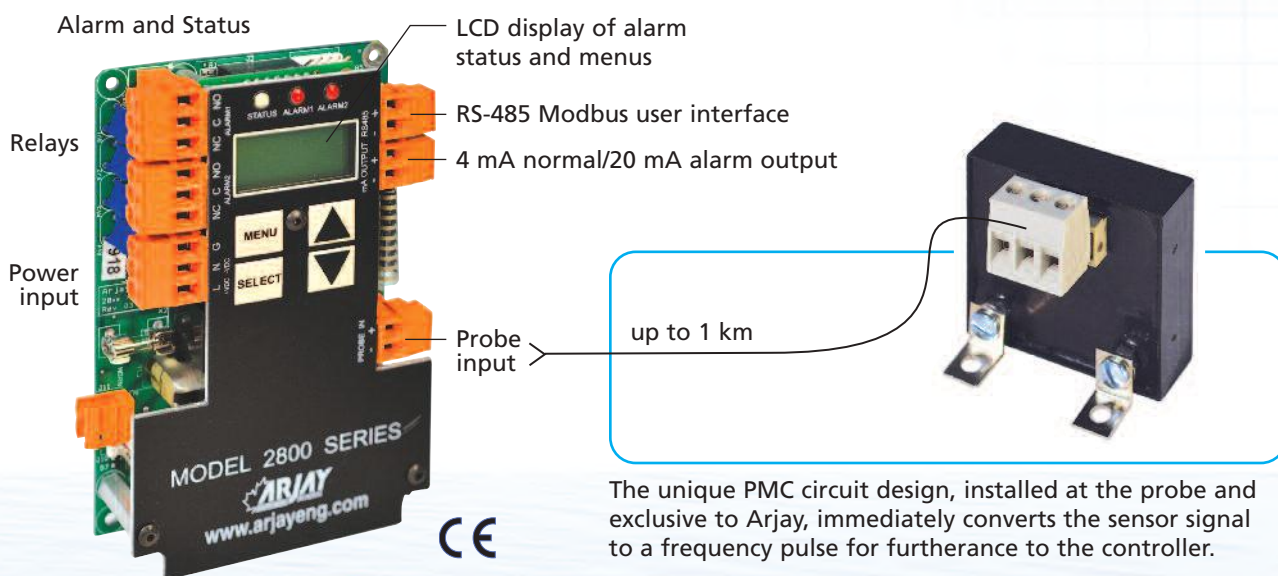

The unique PMC circuit design, installed at the probe and exclusive to Arjay, immediately converts the sensor signal to a frequency pulse for furtherance to the controller.



Arjay Engineering Ltd. 2851 Brighton Road Oakville, Ontario Canada L6H 6C9

<http://www.arjayeng.com> telephone: ++1 905-829-2418 N. America toll free: 1-800-387-9487 fax: ++1 905-829-4701



TABLE OF CONTENTS

1.0	INSTRUMENT OVERVIEW	3
1.1	Features	3
1.2	Model Number vs. Voltage Input.....	3
1.3	Specifications	4
2.0	INSTALLATION.....	6
2.1	Controller Installation	6
	2.1.1 Permanent Power Connection (AC Powered Models only)	6
2.2	Sensor Installation.....	7
	2.2.1 Installation Tip	7
2.3	Electrical Installation	9
	2.3.1 Input / Output Terminal Specification	10
2.4	Glossary of Symbols	11
3.0	STARTUP AND CALIBRATION.....	12
3.1	Startup.....	12
3.2	Menu Flow Chart Background Information	12
	3.2.1 Menu Description.....	12
	3.2.2 Menu Flow Chart	12
	3.2.3 Data Entry.....	13
3.3	2852 Controller Calibration	13
	3.3.1 Site Calibration	13
4.0	SETUP and ALARMS	14
4.1	2852 Controller Setup	14
4.2	2852 Controller Alarms	14
4.3	2852 Controller Network	15
	4.3.1 Modbus Configuration	15
	4.3.2 2800 Series Modbus Register Mapping	16
5.0	MAINTENANCE	17
6.0	TROUBLESHOOTING	18
7.0	FLOW CHARTS	19

TABLE OF FIGURES

Figure 1 – Electrical Installation Overview	9
---	---

1.0 INSTRUMENT OVERVIEW

The Arjay Dry Pump Monitor provides a means for alarm and control when the fluid in a pipe changes from a liquid phase to a dry phase or changes from one liquid type to another (such as water to oil).

The Arjay flanged sensor design contains a capacitance sensor that monitors across the pipe. Water has a high dielectric constant, which results in a high capacitance reading. The capacitance reading decreases when air or a liquid of lower dielectric replaces the water.

The remote mounted Arjay 2852 controller monitors the capacitance change of the sensor and activates a relay contact for use with alarms, pumps, valves, etc.

The complete 2852-DPM system consists of the flange sensor, the PMC card at the sensor, and the 2852 controller.

The model is intended for use in General Purpose non-hazardous areas. For hazardous location use refer to Arjay Engineering Ltd. For appropriate model.

1.1 Features

- Microprocessor based capacitance Controller
- Relay and 4/20mA alarm output
- Modbus protocol via RS-485 for access by Arjay handheld, Central Access Panel or compatible system
- Local Auto calibration or remote calibration via network
- User specified custom features may be added by contacting Arjay Engineering Ltd.

1.2 Model Number vs. Voltage Input

- 2852-DPM-1 100-240 VAC power input
- 2852-DPM-3 12 VDC power input
- 2852-DPM-4 24 VDC power input

1.3 Specifications

Power Input:	12 VDC +15% /-10% or 24 VDC +15% /-10%, 250mA maximum 100VAC – 240VAC +/- 10%, 50/60 Hz, 150mA maximum Note: DC input models must be supplied by Limited Energy power source. Limited Energy means compliance with one of the following requirements: <ul style="list-style-type: none"> - Class 2 circuit according to Canadian Electrical Code, Part, I, C22.1; - Class 2 circuit according to National Electrical Code, NFPA-70; - Limited Power Supply (LPS) according to IEC 60950-1; - Limited-energy circuit according to IEC 61010-1.
Connections to mains supply	Permanent (for AC/DC model)
User Interface:	
Display & Keypad	Two line LCD with Alarm status display, select menu or enter values by keypad (display is internal to housing and used for set-up and diagnostics only)
Communication Interface:	Modbus (RS485)
Analog /Relay Outputs:	
mA Signal Output	4 mA during Normal and 20 mA during an alarm condition, 900 Ohms max OR 450 Ohms max (12VDC Power)
Relay Output	2 SPDT relay, dry, N.O. Contact 5A @ 250 VAC (Resistive) and N.C. Contact 3A @ 250VAC (Resistive), selectable failsafe or non-failsafe, selectable high or low acting alarm, programmable time delay: 0 – 600 seconds
Instrument Performance:	
Measuring Range	0 - 5000 pF (most applications are 100pF to 1000pF)
Accuracy	0.2% of setpoint
Resolution	0.05% of setpoint via network display 0.002% of Full Scale capacitance via network display
Calibration	Single point: Auto calibration
Environmental:	
Operating conditions	Continuous
Operating Temperature	-20 °C to +55 °C controller -60 °C to +55 °C PMC -60 °C to +55 °C Sensor
Relative humidity	0 to 95% (non-condensing)
Altitude	≤2000 m
Installation Category	II
Pollution Degree	2
Equipment mobility	Fixed

Mechanical Specification:	Refer to Dimensional Drawing
Enclosure Rating	Type 4 / IP65 Painted Steel (Blue) Type 4x / IP66 Polycarbonate (Gray) Type 4x / IP66 316 Stainless Steel
Options on Enclosure	Buzzer Pilot Light OR Strobe/Beacon Custom alarms
Approval Standards:	<ul style="list-style-type: none">• UL / IEC 61010-1, 2nd Edition, 2005-07-22 (Electrical Equipment for Measurement, Control, and Laboratory Use; Part 1: General Requirements)• UL file number: E343390• CAN/CSA-22.2 No. 61010-1, 2nd Edition, 2004-07, (Electrical Equipment for Measurement, Control, and Laboratory Use; Part 1: General Requirements)• CE: UL / IEC 61010-1; IEC / EN 61000-4; ISO 9001:2008

2.0 INSTALLATION

NOTE: If any damage to the instrument is found, please notify an Arjay Engineering representative as soon as possible prior to installation.

2.1 Controller Installation

Choose the mounting location in accordance with good instrument practice. Extremes of ambient temperature and vibration should be avoided (see specifications and installation drawing).

The 2850 controller may be mounted up to one kilometer from the PMC card using a minimum 18 gauge, 2-wire SHIELDED cable.

Check the polarity of the + and - wiring between the controller and the PMC prior to powering on the unit; + to + and - to - to avoid damage. Shield of cable should be connected to secondary ground terminal marked as \perp . Incoming Earth ground should be connected to primary ground terminal marked \oplus on sub plate.

Important Note: The controller is factory set in a Failsafe mode. This means that the relays are in an energized state during normal operation. The N.O. relay contact will be held closed and the N.C. relay contact will be held open during a normal condition. This will allow the relay to return to its non-energized (shelf) state during an alarm, fault or power failure condition. Wire accordingly.

Note: Maximum Conduit size for installation size is $\frac{3}{4}$ " FNPT.

2.1.1 Permanent Power Connection (AC Powered Models only)

- 1) Connection to the building wiring system shall be in accordance with the Canadian Electrical Code (CEC), Part 1 in Canada, the National Electrical Code, ANSI/NFPA 70 in the USA, or the local electrical codes of the country where the equipment is being installed.
- 2) A disconnecting device is required. The disconnecting means shall disconnect all current-carrying conductors.
- 3) 15A circuit breaker or equivalent fuse is required.
- 4) An external switch or breaker shall be in close proximity to the equipment and within easy reach of the operator. The switch shall be marked as the disconnecting device for the equipment and include the symbols to its "ON" and "OFF" positions using the following symbols:



Power Off



Power On

- 5) The wiring for AC power should be minimum 18 AWG / 300V or as required by local / country codes.
- 6) After field wiring, the primary wires must be secured to the enclosure by tie-wraps to maintain the separation from the signal wires.
- 7) Wiring diagram for permanent connection: See drawings at the back of this manual.
- 8) Use copper conductors only.

2.2 Sensor Installation

The flange sensor is constructed of PVC and machined in accordance with ANSI/ISO 150# bolt hole configurations. Where specialty piping is used (ie. Victaulic), mount the sensor ONLY in accordance with manufacturers specifications.

The sensor can be mounted on a horizontal or vertical pipe. Choose a location that will provide a good change from a liquid to a dry condition (or liquid to liquid) when the alarm is desired. The inlet to a pump is typical. If the sensor is installed on the downstream side of pump, be sure the liquid drains if the pumps fails to receive water. The sensor operates on the presence and absence of liquid within the flange area.

On a horizontal pipe, orientate the PMC junction box to be at the 12 o'clock position.

2.2.1 Installation Tip

Once the two mating flanges are joined to the pipe, the method for joining three flanges together is as follows:

1. Make sure that all the bolt holes of the matching flanges match up.
2. Insert all bolts
3. Make sure that the faces of the mating flanges are not separated by excessive distance prior to bolting down the flanges. Make sure the bolt holes align with mating flanges.
4. The bolts on the plastic flanges should be tightened by pulling down the nuts diametrically opposite each other using a torque wrench. Complete tightening should be accomplished in stages and the final torque values in the following table should be followed for the various sizes of flanges. Uniform stress across the flange will eliminate leaky gaskets.

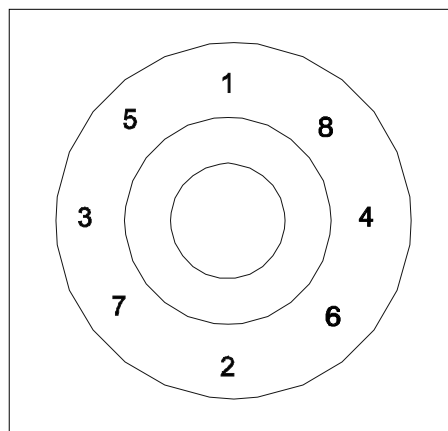

*Based on using flat faced PVC flanges, a full face neoprene gasket, well lubricated hardware, tightening in the proper pattern and applying torque in small increments. For raised face flange assemblies, and PVC to metal flange (or other materials) the above torque recommendations may vary.

The sensor junction box is potted to the ring sensor. DO NOT attempt to re-align the sensor junction box as this will break the potted wiring and render the unit inoperable.

FLANGE SIZE (INCHES)	RECOMMENDED TORQUE (FT.LBS)*
½ - 1 ½	15
2 - 4	30
6 - 8	50
10	70
12 - 24	100

NOTE:

To ensure proper operation and electrical safety, make sure the 2852 enclosure and the PMC junction box are electrically grounded.

If the equipment is used in a manner not specified by the manufacturer, the protection provided by the equipment may be impaired.

2.3 Electrical Installation

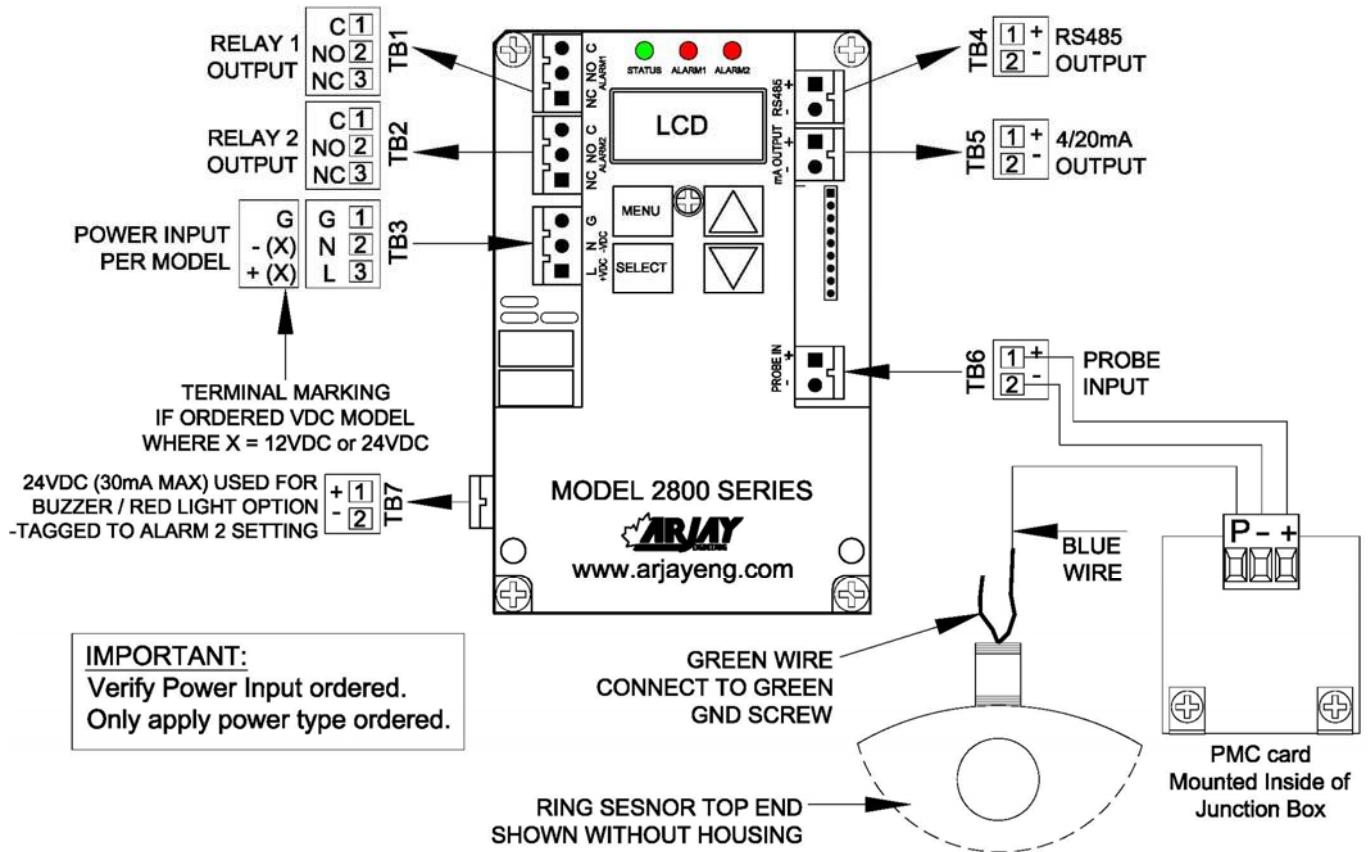

Figure 1 – Electrical Installation Overview

TB1/TB2 - Relay Output

2 SPDT relay, Dry, N.O. Contact 5A @ 250 VAC (Resistive) and N.C. Contact 3A @ 250VAC (Resistive), selectable failsafe or non-failsafe, selectable high or low acting alarm, programmable time delay: 0 – 600 seconds

TB3 - Power Input

Power input as per Model. Check if ordered AC or DC. . Earth ground is connected to G.

TB4 - Network Output

Connect RS485 + and – to the network D+ and D-.

TB5 - 4/20 mA Output (+ and -)

The 4/20 mA is a sourced output referenced to Ground. It is not loop powered.
4mA = Normal 20mA = Alarm

TB6 - Probe Input

Connect '+' to '+' , '-' to '-' between the controller and the PMC card. Check polarity to avoid damage.

TB7 – Buzzer / Red Pilot Light Output (Optional)

The connection will be factory wired if ordered.

2.3.1 Input / Output Terminal Specification

Input Terminals – Power Source					
Terminal ID	Overvoltage category	Rated Voltage (V)	Rated Current/power (A/W/VA)	___ HZ or DC	Specified Mains fluctuation
TB3	II	100-240V	150mA	50/60Hz	± 10%
TB3	II	12 OR 24V	250mA	DC	+15% -10%







Input Terminals – Measuring Circuits					
Terminal ID	Function	Measurement Category	Nominal a.c. or d.c line to neutral voltage / if CAT I, Max. transient overvoltage Ut	Nominal a.c. or d.c current	Rating of insulation required for external circuit
TB6	Frequency	I	15V, 50mA / 0	--	DI * or RI**
TB4	RS485 Communication	I	5V, 5mA / 0	--	DI * or RI**

* Double Insulation

**Reinforced Insulation

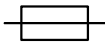
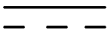
Output Terminals					
Terminal ID	Function	Isolation or protection	Rated V, A	Max. V, A	Load type and nominal
TB1	Load	Relay	N.O. Contact 5A @250VAC & N.C. Contact 3A @250VAC	--	--
TB2	Load	Relay	N.O. Contact 5A @250VAC & N.C. Contact 3A @250VAC	--	--
TB5	Current	Isolator(optional)	- 18V, 20mA, 900Ω - 9V, 20mA, 450Ω	50mA @18V	--
TB7	Voltage	None	24VDC, 30mA	--	Buzzer / Pilot Light

2.4 Glossary of Symbols

	Attention, consult accompanying documents Attention, veuillez consulter les documents ci-joints.		
	Protective Earth Terre de protection		Fuse Coupe-circuit; fusible
	Direct Current (DC) Courant continu		Normally open relay contacts Contacts travail
	Normally closed relay contacts Contacts Repos		Power off Arrô (mise hors tension)
	Power on Marche (mise sous tension)	L	Live Sous tension
N	Neutral Neutre	G	Ground Terre

3.0 STARTUP AND CALIBRATION

3.1 Startup

Check that the power wiring, PMC wiring and coaxial cable are wired in accordance with the electrical installation drawing.

Power On the unit. Allow a 1 hour warm-up period before calibrating.

The Status LED on the controller circuit board should be green. A red Status LED indicates a fault condition. If red, check the Troubleshooting section.

The unit is pre-configured and tested at the factory. However, a quick field calibration is required after power up to tune the sensor to the installation and cable condition. See section 3.3 to calibrate the 2852-DPM .

3.2 Menu Flow Chart Background Information

The control setup, diagnostics, and calibration are accessed using the display and keypad on the controller. The Flow Chart in Section 7.0 provides an overview to the various menus and features. Keep a copy of the flow chart at hand when accessing the internal controller features.

Below is a description of the menu functions.

3.2.1 Menu Description

Since the 2852 controller has a small LCD, some menu descriptions may be in short form. The following are the menu descriptions:

<i>Diags:</i>	<i>Diagnostics</i>	<i>SENSTVTY:</i>	<i>Sensitivity</i>
<i>Cal Pts:</i>	<i>Calibration points</i>	<i>A1:</i>	<i>Alarm relay 1</i>
<i>Auto Cal:</i>	<i>Auto calibrate</i>	<i>A2:</i>	<i>Alarm relay 2</i>
<i>Man Cal:</i>	<i>Manual calibrate</i>	<i>Alrm:</i>	<i>Alarm</i>
<i>Cal Ok:</i>	<i>Calibrate ok</i>	<i>Alrm Lvl:</i>	<i>Alarm level</i>
<i>Cal Err:</i>	<i>Calibrate err</i>	<i>Diff Hi:</i>	<i>Differential Hi alarm set value</i>
<i>mA out:</i>	<i>mA output</i>	<i>Diff Lo:</i>	<i>Differential Lo alarm set value</i>
<i>mA Span:</i>	<i>mA output span</i>	<i>Alrm Del:</i>	<i>Alarm Delay</i>
<i>Sec:</i>	<i>Seconds</i>	<i>^SP:</i>	<i>Relay Setpoint Hi action</i>
<i>ALRM CAL:</i>	<i>Alarm Calibration</i>	<i>vSP:</i>	<i>Relay Setpoint Low action</i>
<i>Cal:</i>	<i>Calibration point</i>		

3.2.2 Menu Flow Chart

The 2852 controller will display **Normal** in its normal operating condition and **Alarm** during an dry sensor condition.

From the main menu, you can select **Cal Only**, **View**, and **Change**.

Cal Only allows a user to calibrate after the equipment is installed. The calibration is required at site after power up or anytime a component or sensor is changed out. A password is required to enter this and is described in the calibration section.

View allows an operator to view the **Calibration** setpoints in pF, the **Alarms** settings (2852 only) such as low or high action, failsafe or non-failsafe and the 0-600 second delay, the **Diagnostics** of raw readings and the **Setup** values such as mA output and ID address. This can be viewed without a password and without risk of changing any values. This information may be requested during technical assistance inquiries.

Change is password protected and allows an operator to enter or change the configuration set-up values indicated in the View. Changes will be required for the initial setup of relay setpoints, delays, span etc. or to re-set the values to the factory default.

3.2.3 Data Entry

Data Entry

Press <▲> / <▼> key to increase / decrease the digital value.

Press <SELECT> key to move the cursor.

Press <MENU> key to abort certain screens

3.3 2852 Controller Calibration

Power up the 2852 Controller. The status LED should be green. The LCD will scroll to the normal operating screen after a series of the following screens (each display for 2 sec.). It may read **Normal** or **Alarm** until a calibration is performed.

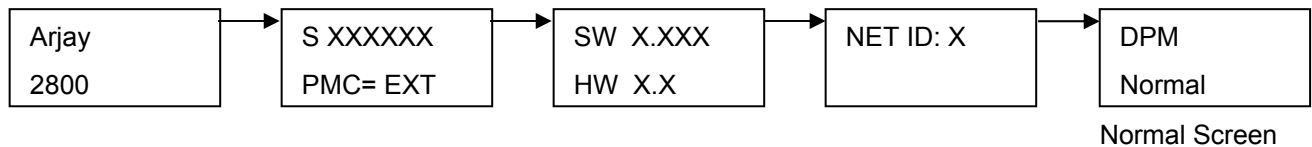

3.3.1 Site Calibration

A factory pre-configuration and set-up has been defaulted into the 2852-DPM. As such, a user set-up is not required in the field. A basic calibration is only required.

For the initial calibration, ensure that the pipe is full of liquid. For Liquid to Liquid applications, the highest di-electric liquid should be in the pipe during calibration.

As per the Flow Chart, press and hold Menu key for 5 seconds to enter the main menu. The display will read the first menu item **Cal only**. Press select key, enter password "2000". A pF reading of the sensor will be displayed. Press select to acknowledge and then press select to accept the new calibration. To abort, press the MENU key.

If the calibration is successful, the display will return to the main operating display.

To verify the sensor and electronics are responsive, force a condition that will drain the fluid within the flange sensor.

The Alarm1 and Alarm2 LEDs on the circuit will activate red. Re-fill the pipe to clear the alarm.

**THIS COMPLETES THE SETUP AND CALIBRATION PROCEDURE FOR THE
2852-DPM Dry Pump Monitor**

4.0 SETUP AND ALARMS

4.1 2852 Controller Setup

The 2852 controller has the following Setup parameters:

1. Sensitivity

The sensitivity determines the amount of pF change required to cause an alarm. The factory default setting is 1.0 pF. This is the factory recommended sensitivity for typical Dry Pump applications. If more sensitivity is required, the adjustment can be changed in the CHANGE MENU by decreasing the pF reading e.g. 0.5pF. Increasing the pF value will increase the amount of liquid loss to required cause an alarm. Since different liquid types can affect the pF change, a direct pF to liquid loss relationship cannot be factory determined. If this setting is changed in the field, it should be tested to confirm an alarm.

2. Alarm Calibration above or below setpoint

This setting advises the controller if the calibrated pF value is above or below the alarm setpoint. For the DPM, the calibration pF value is above the setpoint because the unit is required to alarm at a lower pF value, which indicates oil. The factory default is Above Setpoint.

3. Defaults

Factory settings are pre-configured into the unit based on the most typical set-up required for this application. This provides for a quick and easy calibration at site but can be changed for special applications. If the setup has been changed, this will change back to the factory defaults.

4. Net ID

The ID number is used only for network applications. To communicate on a network, each controller must have a unique ID number. The factory default ID number is 1.

Important: If multiple units on a network have the same address, network errors will result.

5. Filter

Data filtering is used to smooth data from a sudden change and minimize fluctuating readings. For example, a 5 second setting means the calculated value of the capacitance and resulting values of pF will start to respond immediately but will take 5 seconds to reach their final values. The factory default is 0 to provide an immediate and active response.

4.2 2852 Controller Alarms

The two relays on the 2852-DPM operate together. The follow parameters are available as a common setting to the two relays:

1. Delay. Minimum time in seconds for an alarm to exist before the relays change to an alarm state. The relay alarm state depends on the Relay Action and Failsafe settings. The factory setting is 10 seconds. to suppress false alarms due to bubbles or disturbances in front of the sensor.
2. Action. This determines if the Alarms LEDs should activate when the pF reading rises above or below the setpoint. The factory default is below the setpoint because the application of water to oil is a decrease in capacitance.
3. Failsafe. Failsafe typically means that the relay is held in an energized state when in a normal operating condition as opposed to an alarm condition. In an alarm condition, the relay de-energizes which is identical to when the instrument power is shut off. The rationale

is that the alarm condition should match the Power Fail condition. The factory default is Yes for Failsafe.

4.3 2852 Controller Network

The 2852 Controller may be monitored and calibrated via RS-485 protocol compatible digital communications.

Typical features are:

1. Ease of wiring in multiple level point monitoring:

Up to 255 Model 2852's (or other Arjay 2800 Series level monitors) may be connected together in a daisy chain (2 wire communication plus power wiring) connection to an Arjay Remote Access monitor or customer control system which allows viewing data and setup of any of the transmitters on the network. The relay and analog outputs may still be used if necessary.

2. Setup for the 2852 for network operation:

Each 2852 transmitter must have a unique ID number to connect in a network system.

4.3.1 Modbus Configuration

Parameter settings: 9600 Baud Rate; Even Parity, 8 Data Bits and 1 Stop Bit.

Wiring connection: RS485 (+) connect to D+; RS485 (-) connect to D-

4.3.2 2800 Series Modbus Register Mapping

REG	Zero Based	DESCRIPTION	TYPE	No. of Reg
40001	0	Serial Number	float	2
40003	2	Hardware Rev / Software Rev	byte	1
40004	3	Sensitivity / Mode	byte	1
40005	4	Instrument Status	int	1
40006	5	Model / Modbus Address	byte	1
40007	6	Relay2 Setup / Relay 1 Setup	byte	1
40008	7	Password	int	1
40009	8	XA "A" cal parameter	float	2
40011	10	XK "K" cal parameter	float	2
40013	12	XC "C" cal parameter	float	2
40015	14	Filter	float	2
40017	16	Slope – pF per % level	float	2
40019	18	Offset – pF for empty vessel	float	2
40021	20	mA output span value	float	2
40023	22	mA output Zero value	float	2
40025	24	mA output Trim Slope value	float	2
40027	26	mA output Trim Offset vlaue	float	2
40029	28	Cal1 PV: 1st calibration point level value in %	float	2
40031	30	Cal2 PV: 2nd calibration point level value in %	float	2
40033	32	Cal1 pF: 1st calibration point capacitance value in pF	float	2
40035	34	Cal2 pF: 2nd calibration point capacitance value in pF	float	2
40037	36	Relay 1 : Differential High Alarm [% Level]. Only used for Linear Level type. Not used for Single Point Alarm application	float	2
40039	38	Relay 2: Differential High Alarm [% Level]. Only used for Linear Level type. Not used for Single Point Alarm application	float	2
40041	40	Relay 1: Differential Low Alarm [% Level] OR Single Point Alarm [pF]. Single Point Cal: used as captured pF during cal	float	2
40043	42	Relay 2: Differential Low Alarm [%Level]. Only used for Linear Level type. Not used for Single Point Alarm application	float	2
40045	44	Relay 1 On delay [in seconds]. Only used for Linear Level or Single Point Alarm application	int	1
40046	45	Relay 2 On delay [in seconds]. Only used for Linear Level type. Not used for Single Point Alarm application	int	1
40047	46	mA Analog Output	float	2
40049	48	Oscillation Frequency	float	2
40051	50	Frequency	float	2
40053	52	Capacitance	float	2
40055	54	Filtered Capacitance	float	2
40057	56	Level	float	2

5.0 MAINTENANCE

There is no routine cleaning required for this controller.

6.0 TROUBLESHOOTING

CONDITION	DO THIS
1. Status LED is OFF and the LCD display is off	Check the power to the unit. If the unit is a 12VDC or 24VDC model, check the external source and polarity is correct. If the unit is a 100-240VAC model, then check the Line, Neutral and Ground wiring is correct.
2. If the status LED is RED	<p>This indicates a major error such as memory failure, no sensor signal etc. Check the following:</p> <ul style="list-style-type: none"> • Make sure the PMC is installed • Make sure the PMC wiring is correct and there are no breaks in the wiring. At the controller, measure across the Probe Input terminals with a DC meter. Make sure "Common" lead of meter is on '-' terminal. It should read (+) 8 to (+)10 VDC with the PMC connected and approximately 20 to 24 VDC with the PMC terminal disconnected. • Microprocessor may have lost its parameters due to a surge in the line. Go to Diagnostic Menu (see Flow Chart) to check the Calibration values, frequency and capacitance values • Call Arjay Technical Support.
3. No mA output OR incorrect mA output.	<p>IMPORTANT: THE UNIT SOURCES mA OUT FROM THE mA OUTPUT TERMINAL. <u>THIS TERMINAL SHOULD NOT BE CONNECTED TO +24V.</u> IT IS NOT A 2 WIRE mA TRANSMITTER. See Figure 4 for Electrical hookup details.</p> <ul style="list-style-type: none"> • Disconnect external wires from mA output and measure with mA Meter. • Check the mA output Action (direct or inverse) and mA output Span are set as desired. See section 7.0 Flow chart / Change menu. • If the mA output still does not match the level, then call Arjay Technical Support.
4. False Alarms	<ul style="list-style-type: none"> • Add some time delay in the unit • Make sure there is no external interference and electrical noise such as agitators, high voltage interference, turbulent flow, etc • Adjust the sensitivity to the next higher value. Test after any changes to confirm an alarm.
5. Not sensitive to change	<ul style="list-style-type: none"> • Make sure that there is a liquid change at sensor location. • Increase sensitivity by adjusting capacitance to a lower value (e.g. 0.5pF).

ARJAY ENGINEERING TECHNICAL SUPPORT

(800) 387-9487

+1 (905) 829-2418

www.arjayeng.com

7.0 FLOW CHARTS

NORMAL OPERATING DISPLAY

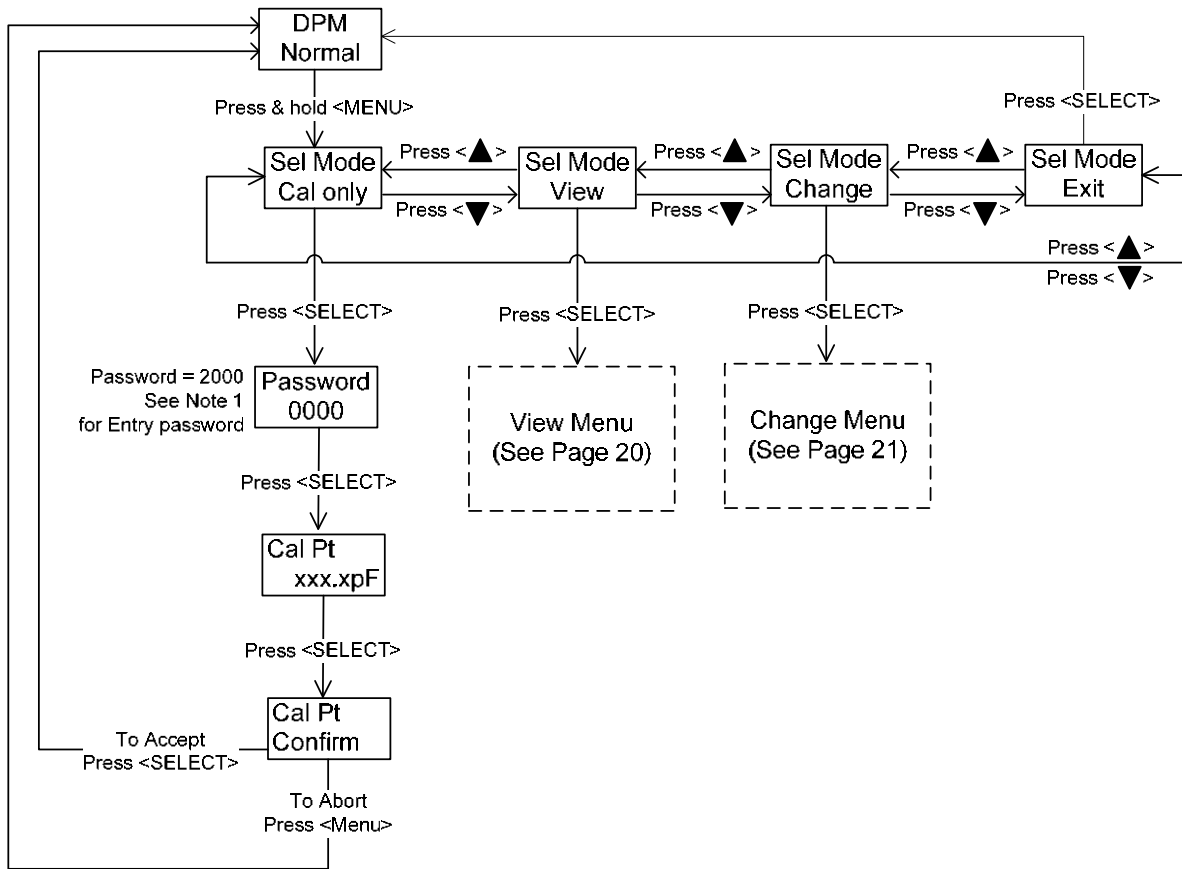

Note 1: Data Entry

Press <▲> / <▼> key to increase / decrease the digital value.

Press <SELECT> key to move the cursor.

CHANGE MENU

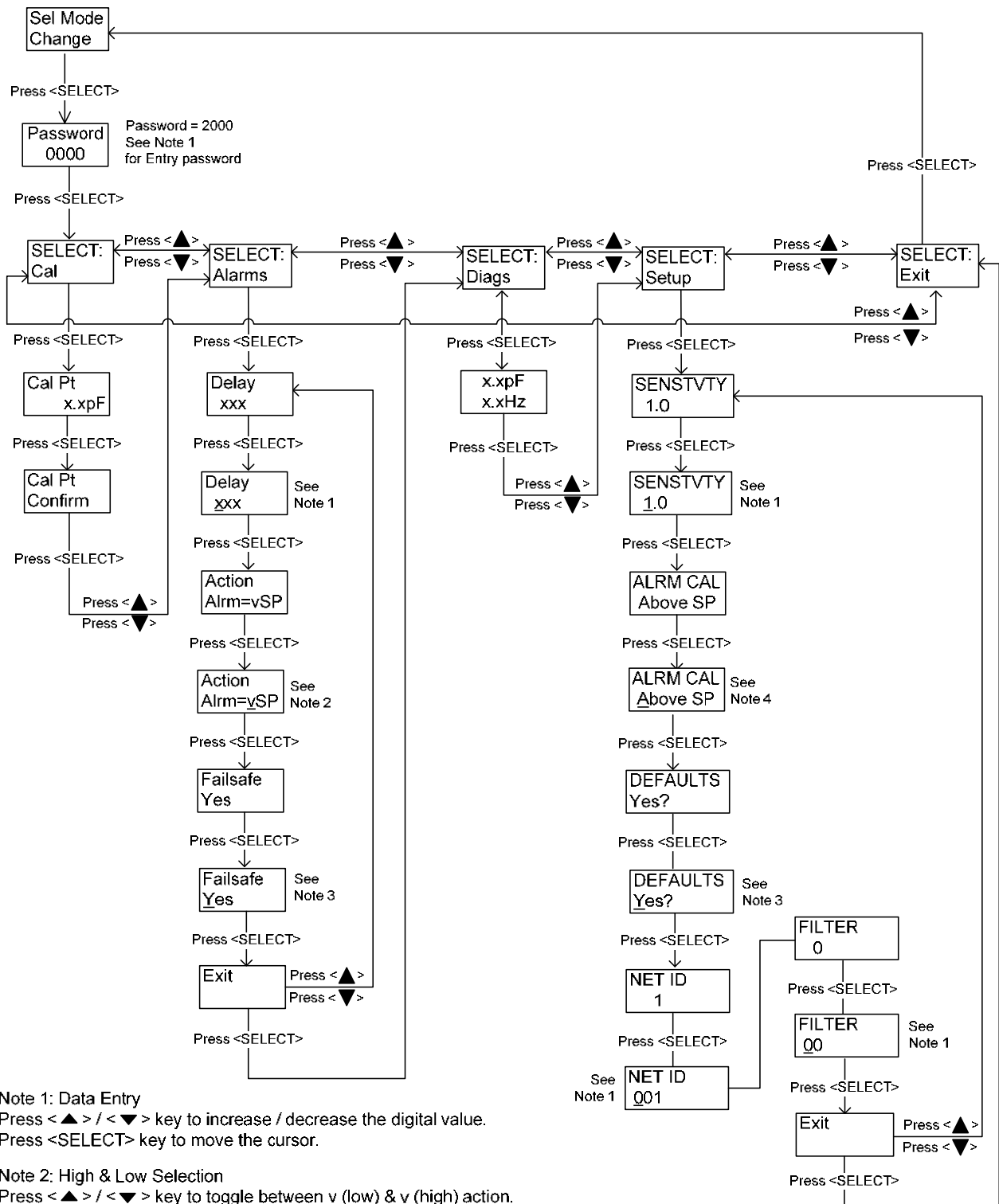

Note 1: Data Entry
 Press <▲> / <▼> key to increase / decrease the digital value.
 Press <SELECT> key to move the cursor.

Note 2: High & Low Selection
 Press <▲> / <▼> key to toggle between v (low) & v (high) action.

Note 3: Yes & No Selection
 Press <▲> / <▼> key to toggle between Yes & No action.

Note 4: Above & Below Selection
 Press < > / < > key to toggle between Above & Below action.