

**Thank you for choosing a NIVELCO instrument.**  
**We are sure that you will be satisfied throughout its use!**

# NIVOSWITCH

SERIES R-400, R-400 EX  
 VIBRATING FORK LEVEL SWITCHES

## 1. APPLICATION

A NIVOSWITCH R-400 type vibration forks are applicable for level switching or flow switching tasks of normal and explosive liquids. Overflow or dry run protection as well as pump control is also possible with the NIVOSWITCH vibration forks in low/high fail-safe operation mode.

## 2. TECHNICAL DATA

### 2.1 GENERAL DATA

R-400 / R-400 Ex	
Medium pressure	40 bar, PP flange: 6 bar see „Temperature diagrams“
Probe length	0.69 m... 3 m
Material of wetted parts	DIN 1.4571, PFA coating
Medium temperature	-40°C... +130°C see table in 5.1 and diagrams
Ambient temperature	-40°C...+70°C see table in 5.1 and diagrams R**4**L Ex ; R**4**M and R**4**K -25°C...+70°C
Liquid density	≥ 0.7 kg/dm <sup>3</sup>
Liquid viscosity	≤ 10000 mm <sup>2</sup> /s (cSt)
Response time	When immersed
	When free
Output mode indication	Bi-colour (LED)
Operation test	Output can be changed by test magnet

### 2.2 TWO-WIRE DC, NORMAL AND EX APPROVED VERSION

TYPE	2-wire DC		
	R**4**6 R**4**8 Ex	R**4**K R**4**L Ex	R**4**7 R**4**9 Ex
Electric connections	Connector		3 m cable (2 x 0.5 mm <sup>2</sup> )
Ingress Protection	IP 65	IP 67	IP 68
Output	DC current change: When free: 9 ± 1 mA; When immersed: 14 ± 1 mA		
Consumption	< 0,5 W		
Power supply (U)	15 ... 29 V DC Provided by the PKK-312-8 Ex remote switching unit for the Ex version		
Setting operation mode	By switch on the remote switching unit (Low fail-safe, High fail-safe)		
Electrical protection	Class III.		
Ex protection mark of RC*4**Ex and RG*4**Ex	⊕ II 1G Ex ia IIC T6...T4 Ga		
Ex protection mark of RA*4**Ex	⊕ II 1G Ex ia IIB T6...T4 Ga		
Intrinsically safe data	U < 29 V, I < 100 mA P<1,4 W, C <sub>eq</sub> < 7 nF L <sub>eq</sub> ≈ 0 For temperature classes see 5.1.		

User's manual



NIVELCO



Manufacturer

**NIVELCO Process Control Co.**  
 H-1043 Buda pest, Dugonics u. 11.

Phone: (36-1) 889-0100 ■ Fax: (36-1) 889-0200  
 E-mail: sales@nivelco.com ■ www.nivelco.com

### 2.3 2-WIRE AC AND 3-WIRE DC VERSIONS

TYPE	2-WIRE AC		3-WIRE DC		
	R**4**1	R**4**2	R**4**3	R**4**M	R**4**4
Electric connections (wire cross section)	Connector	Integral cable (4 x 0.75 mm <sup>2</sup> ) max length 30 m	Connector		Integral cable (5 x 0.5 mm <sup>2</sup> ) max length 30 m
Mechanical protection	IP 65	IP 68	IP 65	IP67	IP 68
High/low mode setting	Connection within connector	Wire selectable	Switch selectable	Connection within connector	Wire selectable
Output	2-wire AC, for serial connection		Field selectable, PNP/NPN transistor switch		Field selectable, galvanically isolated PNP/NPN transistor switch
Output protection	—		Reverse polarity, overcurrent and short-circuit protection		
Supply voltage	20 ... 255 V AC, 50/60 Hz		12 ... 55 V DC		
Consumption	Depending on load		< 0.6 W		
Voltage drop in switched-on state	< 10.5 V		< 4.5 V		
Electrical protection	Class I		Class III		
Current load	max. continuous	350 mA AC 13	I <sub>max</sub> = 350 mA DC / U <sub>max</sub> = 55 V DC		
	min. continuous	10 mA / 255 V, 25 mA / 24 V	—		
	max. impulse	1.5 A / 40 ms	—		
Residual current (in switched off state)	< 6 mA		< 100 µA		

### 2.4 ACCESSORIES

- User's manual
- Declaration of conformity
- 1 pc Sealing ring (2 mm thick KLINGER OILIT)
- Warranty Card
- RPS-101 type test magnetic-screwdriver (optional)
- Sliding sleeve for adjustable types: RPH-112 (optional)

### 2.5 ORDER CODES

NIVOSWITCH R [ ] [ ] - 4 [ ] [ ] - [ ] \*

TYPE	CODE
Tube + plastic (PFA) coated fork	A
Tube + 1.4571 fork	C
Tube + highly polished fork	G

PROCESS CONNECTION	CODE
BSP 1"	M
BSP 1 1/2"	H
NPT 1"	P
NPT 1 1/2"	N
DN50 PN16 PP DIN	F
DN50 PN40 1.4571 DIN	G
ANSI 2" RF150 PP	A
ANSI 2" RF600 1.4571	B
JIS 10K 50A PP	J
JIS 40K 50A 1.4571	K
Triclamp 1 1/2"	T
Triclamp 2"	R
DN40 Pipe coupling	D
DN50 Pipe coupling	E

PROBE LENGTH	CODE
Short (69 mm)	00
Standard (125 mm)	01
0,2 ... 3 m	02 ... 30

OUTPUT	CODE
2-wire AC + connector	1
2-wire AC + cable	2
3-wire DC + connector	3
3-wire DC + cable	4
2-wire DC + connector	6
2-wire DC + cable	7
2-wire DC + connector + Ex	8
2-wire DC + cable + Ex	9
2-wire DC + M12 connector	K
2-wire DC + M12 connector + Ex	L
3-wire DC + M12 connector	M

\* Ex version with Ex mark.

Note: Flanged versions have 1" process connection.

## 2.6 TEMPERATURE DIAGRAMS

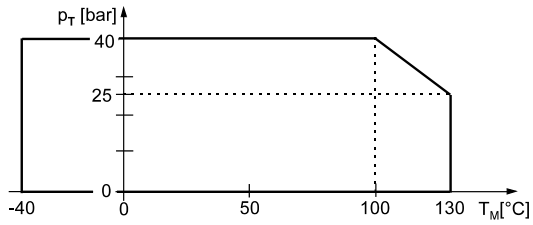

Pressure [ $p_T$ ] as a function of temperature [ $T_M$ ] for all versions (except PP flanged version)

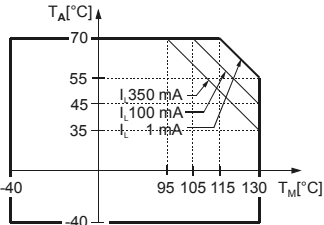

Temperature limits of DC versions, [ $I_L$ ] load current

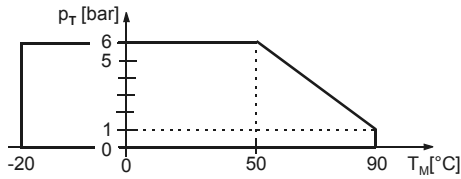

Pressure [ $p_T$ ] as a function of temperature [ $T_M$ ] for PP flanged version

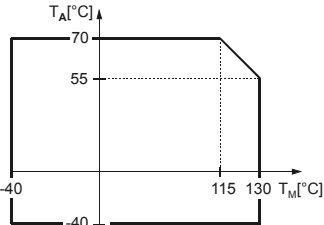

Temperature limits of AC versions, [ $T_A$ ] ambient temperature [ $T_M$ ] medium temperature

## 2.7 RESPONSE TIME DIAGRAM (WHEN GETTING FREE)

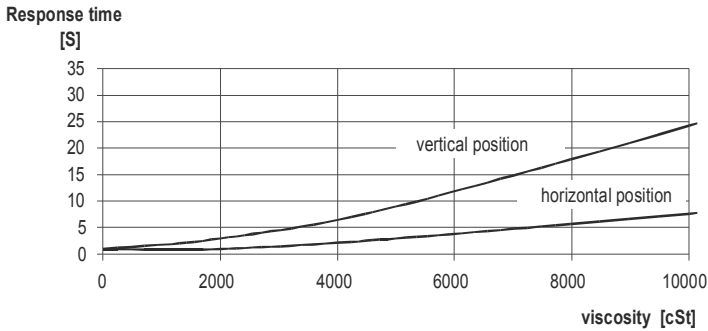

## 2.8 DIMENSIONS

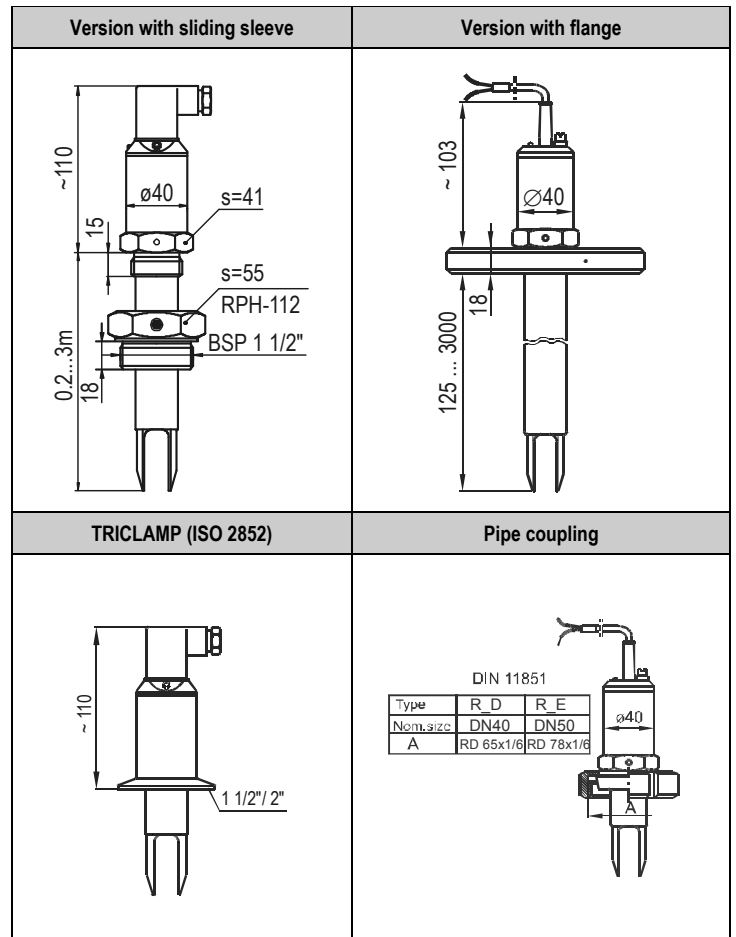
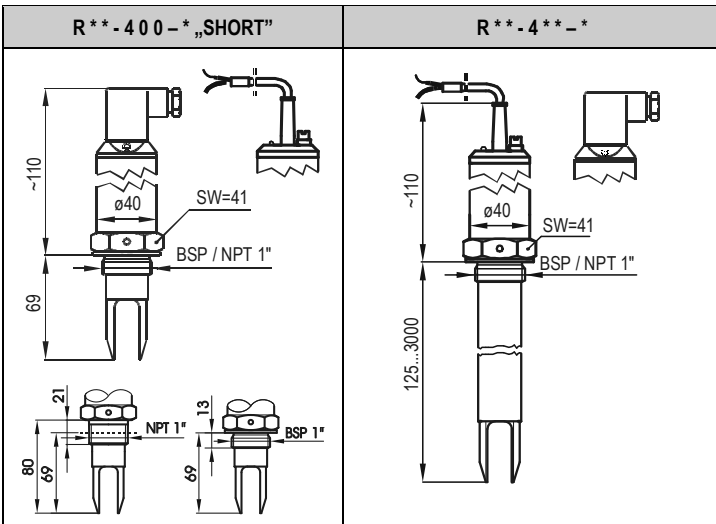

## 2.9 MATERIALS

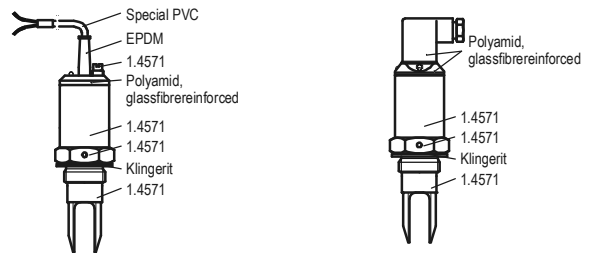

## 3. INSTALLATION

Prevent the device from any mechanical damage.

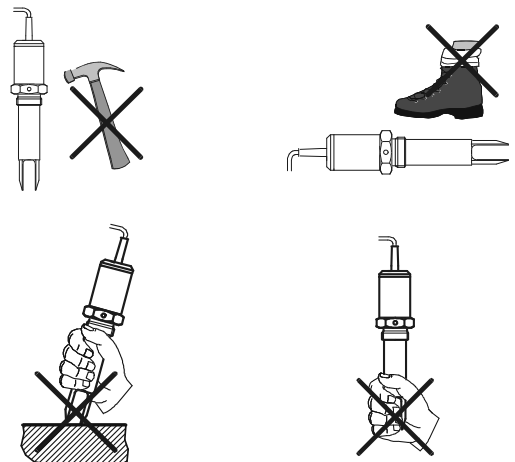

For positioning the fork-tines, use the marking on the hexagonal neck.

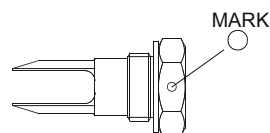

- If directional positioning of the fork-tines is needed (side mounting), use the TEFLON (PTFE) tape to seal the thread and position the fork-tines to the desired direction.
- In this case vertical positioning of the fork-tines is suggested.

### Low viscosity liquids

On applications, where the fork-tines are easily freed from the process medium, any of the mountings shown to the right is possible.

### High viscosity liquids

On applications, where the fork-tines are not freed easily from the process medium, the horizontal mounting is recommended.

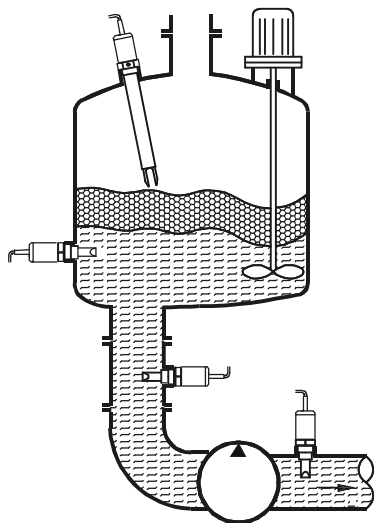

Installation options

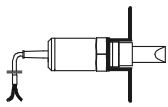

Threaded version

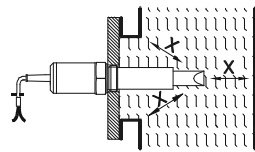

Flanged version, critical distances:  $x > 5 \text{ mm}$

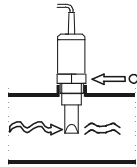
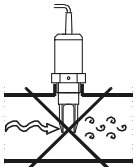

For pipe mounting, fork-tines must be parallel to the direction of flow

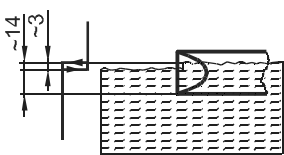

Switching point and differential for water at 25 °C

Switching point as well as the switching differential depends on liquid density and mounting position.

## 4. WIRING

### 4.1. 2 WIRE AC VERSIONS

$R^{**} - 4^{**} - 1$  connector  
 $R^{**} - 4^{**} - 2$  cable

**DO NOT POWER UP THE DEVICE WITHOUT A LOAD CONNECTED IN SERIES WITH THE UNIT AND WITHOUT GROUNDING IT!**

#### 4.1.1. Version with connector

$R^{**} - 4^{**} - 1$

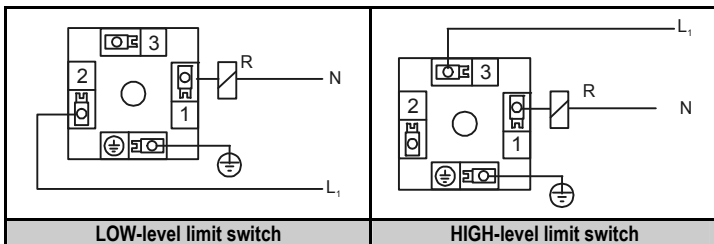

Terminal block cover can be rotated in 90° steps to ensure appropriate cable positioning.

#### 4.1.2. Version with cable $R^{**} - 4^{**} - 2$

This version is with 4 wire cable equipped. Only one of the black and brown wires is used, dependent on the operating mode (High or Low).

Provide also a terminal block connection for the unused wire.

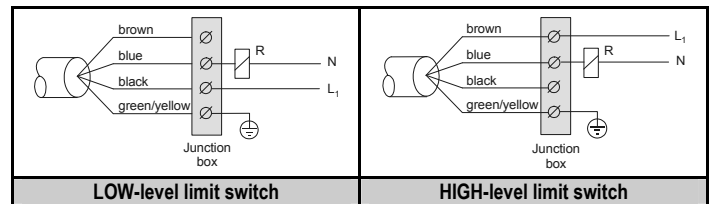

### 4.2. 3 WIRE DC VERSIONS

In case of overload caused by short circuit, transistor will switch on and off, and LED will start to blink.

#### 4.2.1. Version with connector $R^{**} - 4^{**} - M / R^{**} - 4^{**} - 3$

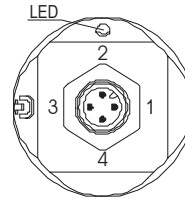

"M" - Operation mode  
 H= High - level limit switch  
 L= Low - level limit switch

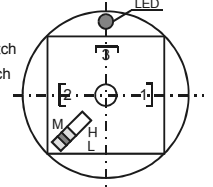

#### 4.2.1.1. Wiring of 3-wire DC version with connector in case of relay application

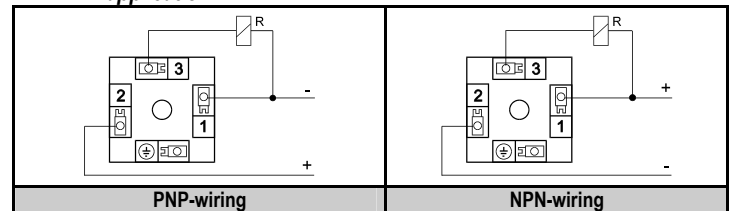

Terminal block cover can be rotated in 90° steps to ensure appropriate cable positioning.

#### PNP - wiring

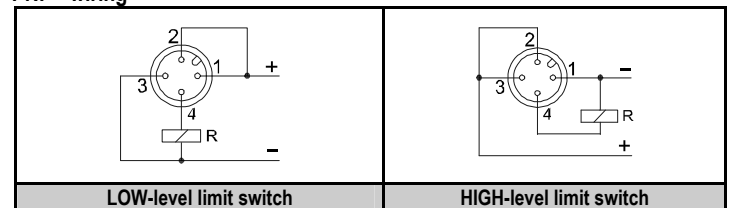

#### NPN - wiring



#### 4.2.1.2. Wiring of 3-wire DC version with connector in case of PLC application

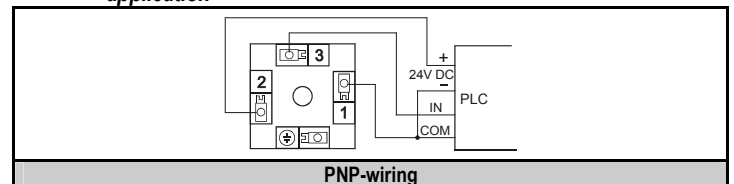

#### 4.2.2. Version with cable $R^{**} - 4^{**} - 4$

##### 4.2.2.1. Wiring in case of relay applications

##### PNP-wiring

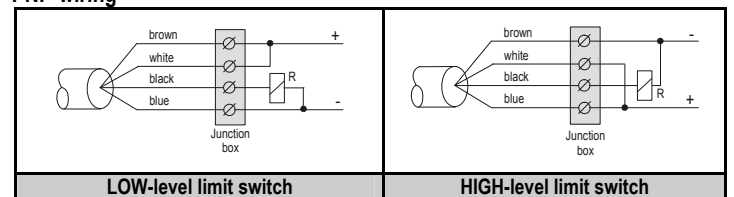

## NPN-wiring

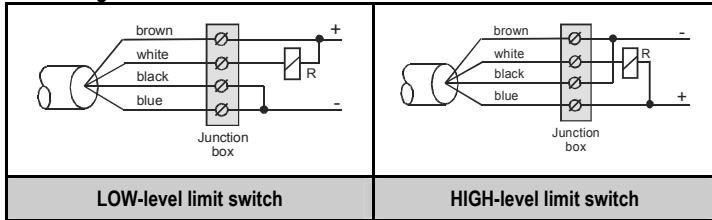

### 4.2.2.2. Wiring in case of PLC applications

## PNP-wiring

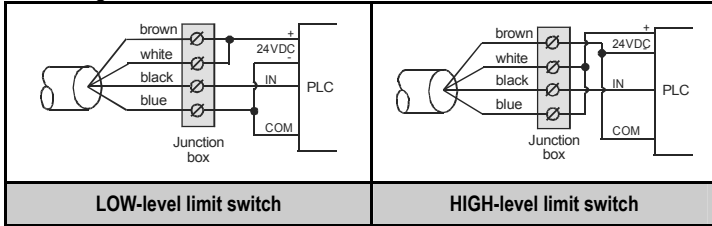

## 4.3. 2-WIRE DC VERSIONS, NORMAL OR EX

### 4.3.1. Version with connector

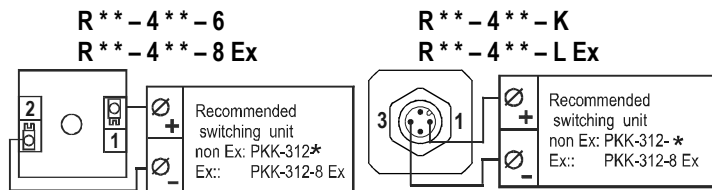

### 4.3.2. Version with cable

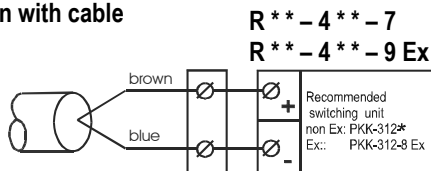

## 5. PUTTING INTO OPERATION, ADJUSTMENT

Check connecting of the wires and position of the mode of operation switch (if there is). After connection and power up the tuning fork is operational.

Operation diagram of the NIVOSWITCH:

POWER SUPPLY	FORK	MODE	DISPLAY (LED)	OUTPUT
ON	Immersed	HIGH	RED	OFF
		LOW	GREEN	ON
	Free	HIGH	GREEN	ON
		LOW	RED	OFF
NONE	Free or immersed	HIGH or LOW	NOT LIT	OFF

### Operation diagram of the 2-wire DC version

FORK	DISPLAY (LED)	OUTPUT
Immersed	RED	14 ± 1 mA
Free	GREEN	9 ± 1 mA

## OPERATION TEST

Correct operation of the switching circuit of an installed device can be tested with the optional test magnet (RPS-101). Moving the test magnet in front of the marking on the cover of the housing the device must perform a switching (LED changes colour).

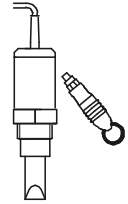

## 5.1. APPLYING EX APPROVED MODELS

Applying Ex approved models take into consideration the table of allowed temperatures listed below.

TEMPERATURE CLASSIFICATION	T6	T5	T4
T <sub>ambient</sub>	70 °C	60 °C	60 °C
T <sub>medium</sub>	70 °C	75 °C	130 °C

Table of possible temperatures

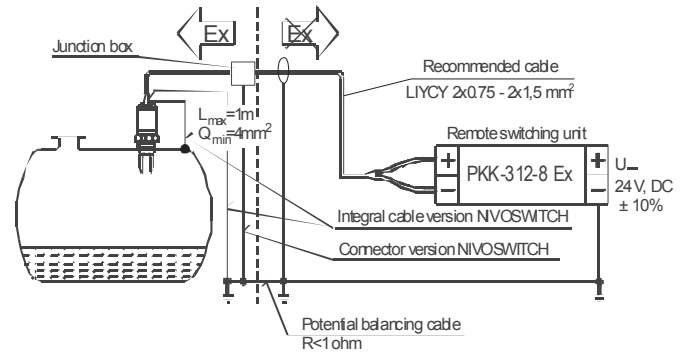

## 5.2 CONDITIONS OF SAFE OPERATION

ATEX II 1G Ex ia IIC T6...T4 Ga and II 1G Ex ia IIB T6...T4 Ga approved vibrating forks should be powered by intrinsically safe [Ex ia IIC or IIB] certified and approved devices.

The cleaning of these units are allowed only with a wet rag.

Junction box shall be applied for R\*\*-4\*\*-9 Ex versions with cable connection. Junction box shall meet the appropriate protection requirements.

The instrument has built-in overvoltage protection, so:

- Outer grounding of the electric housing shall be connected to the steel silo wall with a minimal 4mm<sup>2</sup> cross sectioned, shielded copper cable — outside the Zone 0 — within the distance of 1 m from the boundary of the Zone 0.
- According to point 6.3.12 of EN 60079-11 standard dielectric strength test is not allowed to perform with the instrument.

To avoid the danger of electrostatic charge accumulation, in case of the coated version RA\*\*-4\*\*-\*\* type the following safety rule shall be observed:

- Measured medium shall be an electrostatic conductor, electrical resistivity of the medium shall be ≤ 10<sup>4</sup> Ω.
- Speed of the filling and emptying process shall be chosen properly according to the measured medium.

## 6. MAINTENANCE, REPAIR

In some instances, the sensor probe may need occasional cleaning to remove surface deposits. This must be carried out gently, without harming the vibrating section of the vibrating fork.



## 7. STORAGE CONDITIONS

Ambient temperature: -25 ... +60°C  
Relative humidity: max. 98 %

## 8. WARRANTY

NIVELCO provides warranty of 3 (three) years in compliance with details described in the Warranty Card.

rcm4004a0600h\_08  
2013. February

NIVELCO reserves the right to change technical specifications without notice.