

# Microcell™

# Installation Manual

**CAUTION**

It is essential that all instructions in this manual be followed precisely to ensure proper operation of the equipment.

## **NOTICE**

The content of this document is the intellectual property of Kistler-Morse® Corporation. Any reproduction or translation of this document without the written authorization of a Kistler-Morse® corporate officer is prohibited.

## **CAUTION**

Follow these rules if welding is done on the vessel after installation of the Microcell™ system. The electrical current of the welder may pass through the Microcell™, causing damage to the sensor and possibly to the signal processor. To avoid damage, follow these precautions:

1. Disconnect the Microcell™ cables from the signal processor.
2. Ground the welder as close to the welding joint as possible. The welding ground must be between the Microcell™ and the weld joint to prevent the welding current from going through the Microcell™ to earth ground.

# TABLE OF CONTENTS

<b>CHAPTER 1. INTRODUCTION</b> .....	1
Equipment Description .....	1
Applications .....	1
Manual Conventions .....	1
<b>CHAPTER 2. PRE-CHECK PROCEDURES</b> .....	2
Introduction .....	2
Application Verification .....	2
Order Verification .....	2
Microcell™ Order .....	2
Microcell™ Installation Equipment .....	3
Junction Box and Field Wiring Equipment .....	3
Checking Equipment .....	3
Visual Check .....	3
Functional Check .....	3
Testing with Kistler-Morse® Test Meter .....	3
Testing with Digital Multimeter (DMM) .....	4
<b>CHAPTER 3. MICROCELL™ INSTALLATION ON VERTICAL COLUMN LEGS</b> .....	5
Introduction .....	5
Mounting Locations .....	5
Microcell™ Sets .....	5
Best Performance .....	5
Standard Performance .....	5
Horizontal Distribution of Microcell™ Sets .....	6
Vertical Location of Microcell™ Sets .....	6
Column Legs without X-Braces .....	6
Column Legs with X-Braces .....	6
Installing Microcell™ Sets .....	8
Surface Preparation .....	8
Drill and Tap .....	8
Mounting the Microcell™ Sets .....	9
Mounting Junction Box .....	10
Mounting Location .....	10
Junction Box Installation .....	11
Wiring Microcells™ to Junction Box .....	11
Wiring Junction Boxes Together and to Signal Processor .....	13
Installing Insulation for Outdoor Vessels (Optional) .....	15
Insulation Order and Installation Equipment .....	15
Installing Brace Wrap .....	15
<b>CHAPTER 4. MICROCELL™ INSTALLATION ON HORIZONTAL BEAMS</b> .....	17
Introduction .....	17
Mounting Locations .....	17
Microcell™ Sets .....	17
Distribution of Microcell™ Sets .....	17
Installing Microcell™ Sets .....	20
Surface Preparation .....	20
Drill and Tap .....	20
Mounting Microcell™ Sets .....	21

# TABLE OF CONTENTS

Mounting Junction Box .....	22
Mounting Location.....	22
Junction Box Installation .....	22
Wiring Microcell™ Sets to Junction Box.....	23
Wiring Junction Boxes Together and to Signal Processor .....	24
<b>CHAPTER 5. SYSTEM CALIBRATION .....</b>	<b>27</b>
Introduction .....	27
Live Load Calibration .....	27
Adding a Known Quantity of Material.....	27
Removing a Known Quantity of Material.....	28
Manual Calibration .....	28
<b>CHAPTER 6. TROUBLESHOOTING.....</b>	<b>29</b>
Problem 1. Small Amplitude Changes or Erratic Fluctuations in Display Readings .....	29
Problem 2. Repeatable Drift Over a 24-hour Period .....	30
Problem 3. Sudden Change in Weight Reading or System Requires Frequent Recalibration.....	31
<b>APPENDIX A. MICROCELL™ SPECIFICATIONS.....</b>	<b>32</b>
<b>APPENDIX B. GLOSSARY .....</b>	<b>34</b>
<b>APPENDIX C. ALTERNATE METHOD FOR CHECKING OUTPUT .....</b>	<b>35</b>
<b>APPENDIX D. SPARE PARTS RECOMMENDATIONS .....</b>	<b>36</b>
<b>APPENDIX E. TECHNICAL DRAWINGS .....</b>	<b>37</b>

---

# CHAPTER 1. INTRODUCTION

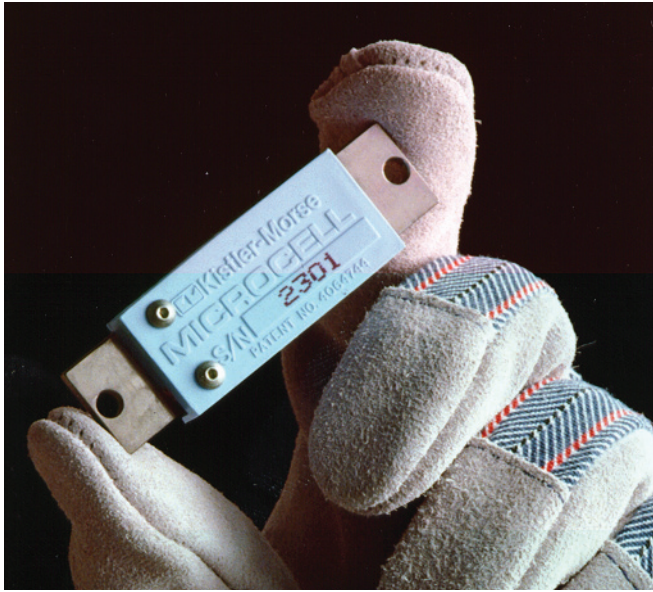

Figure 1-1. The Kistler-Morse® Microcell™.

## EQUIPMENT DESCRIPTION

The Microcell™ (Figure 1-1) is a highly sensitive bolt-on strain gage sensor used to determine the weight of material contained in storage vessels. Microcell™ sets bolt onto a vessel's metal support structure. As weight is added to or removed from the vessel, the vessel support structure experiences strain changes proportional to the weight changes. The Microcell™ detects the strain changes and produces a voltage output proportional to those changes, thus indicating the change in weight. Kistler-Morse® signal processors convert the Microcell™ voltage outputs to weight or level. Refer to Appendix A for specifications.

The Microcell™ is easy to install. It mounts to the surface of the structural support and never comes in contact with the vessel contents. Used in many different industries, it can weigh any type of material stored in a vessel with metal support members. The Microcell™ is rugged, can operate in industrial environments, and requires no periodic maintenance. It is immune to electrical noise due to its high-level output voltage.

## APPLICATIONS

The 3" Microcell™ can be installed on carbon steel, stainless steel, or aluminum vessel supports. The 2" Microcell™ can be installed on carbon steel vessel supports only. Refer to Appendix A (Microcell™ Specifications) for stress limits on each type of Microcell™.

Microcell™ sets can be installed on leg-supported and beam-supported vessels. Refer Chapter 3 for installation details on installing Microcell™ on vertical column legs. Refer to Chapter 4 for installation details on installing Microcell™ on horizontal beams.

Contact Kistler-Morse® for information on non-standard applications.

Be sure to read the entire installation procedure pertaining to your application before beginning installation.

## MANUAL CONVENTIONS

Three kinds of special explanations appear throughout the manual. The format and significance of each is defined below:

### **WARNING**

**Possible danger to people. Injury may result if this information is ignored.**

### **CAUTION**

Possible risk to the product. The Microcell™ or other equipment may be damaged if this information is ignored.

### **Note**

Contains additional information about a step or feature critical to the installation or operation of the Microcell™.

---

# CHAPTER 2. PRE-CHECK PROCEDURES

## INTRODUCTION

This chapter describes the pre-check procedures for Microcell™ sets. Verifying the application and checking the Microcell™ sets before installation will ensure installation of properly working equipment that will provide accurate monitoring of vessel contents.

## APPLICATION VERIFICATION

Prior to ordering Microcell™ sets, be sure to have read the Microcell™ Selection Guide (Kistler-Morse® #97-5023) and completed the appropriate Application Data Form (Kistler-Morse® #97-5025 for Microcells™ on vertical column legs or Kistler-Morse® #97-5024 for Microcells™ on horizontal beams). A copy of the completed form was returned with both the order acknowledgment and equipment shipment. If you cannot locate the form, contact Kistler-Morse® to get another copy before proceeding. Review the information on the form now to verify the application details.

### **Note**

If the calculated stress on the Application Data Form is outside the following ranges, this is a special application:

3" Microcell™:	2,500 psi - 7,500 psi (1.8kg/mm <sup>2</sup> - 5.3kg/mm <sup>2</sup> )
2" Microcell™:	3,750 psi - 11,250 psi (2.6kg/mm <sup>2</sup> - 7.9kg/mm <sup>2</sup> )

Contact Kistler-Morse® before proceeding further with a special application.

## ORDER VERIFICATION

Prior to beginning installation, verify the order is complete and assemble additional equipment needed for the installation.

### **MICROCELL™ ORDER**

The following are included with the order (quantities dependent on application):

#### STANDARD

Microcell™ set, each complete with:

- Sensor
- Environmental Cover
- #8-32 socket head cap screws (2)
- #8 hardened flat washers (2)

JB1 or JB2 Junction Boxes, each complete with:

- Terminal board
- Watertight fittings (4)
- Watertight plugs (for any cable openings that will not be used)

Installation Kit, each complete with:

- Microcell™ drill template with #8-32 socket head cap screw
- #29 drill bit
- #8-32, 2-flute, spiral-point tap
- Sikaflex 1A polyurethane sealant or Dow Corning RTV 738 or RTV 739 and Material Safety Data Sheet (MSDS)
- Rust-inhibiting silicone grease

#### OPTIONAL

Insulation and insulation hardware (if best performance is required for an outdoor installation on column legs)

If any items are missing from the order, contact Kistler-Morse® before proceeding. Substituting parts without Kistler-Morse® approval may cause system problems and will void the warranty.

### **Note**

A signal processor and its manual are required to calibrate the system. If using an existing signal processor, this will not be included in the order.

---

## MICROCELL™ INSTALLATION EQUIPMENT

Tape measure  
Marking pen  
Kistler-Morse® Test Meter  
Kistler-Morse® Microcell™ Sensor Drill Template  
Drill motor  
Tapping fluid  
Tap handle  
Disk grinder, 4½" (114 mm) or larger, or belt grinder  
Sandpaper (coarse and fine)  
Degreaser (isopropyl alcohol or acetone)  
Level  
Caulking gun  
9/64" hex T-handle driver  
Digital Multimeter (DMM)  
Tape (electrical or masking)

### Note

If the Microcell™ sets will be installed by Kistler-Morse®, the service technician provided by Kistler-Morse® will bring this equipment on site with the tool kit. If the Microcell™ sets will be installed by the customer, the purchase of a Kistler-Morse® Test Meter is highly recommended to simplify the installation.

## JUNCTION BOX AND FIELD WIRING EQUIPMENT

Drill motor  
#29 drill bit  
#8-32, 2-flute, spiral-point tap  
Tap handle  
Tapping fluid  
9/64" Allen wrench  
#8-32 socket head cap screws  
#8 flat washers (3/16" inner diameter, 7/16" outer diameter)  
Belden™ 8791, 18 gauge, 3-conductor shielded interconnect cable or equivalent (for up to 1,000 ft (305m) length)  
Belden™ 8618, 16 gauge, 3-conductor shielded interconnect cable or equivalent (for 1,000 ft to 2,000 ft (305m to 610m) length)  
Conduit and fittings or cable tray  
Caulking gun  
Sikaflex 1A polyurethane sealant or Dow Corning RTV 738 or RTV 739

## CAUTION

Only use Sikaflex 1A polyurethane sealant or Dow Corning RTV 738 or RTV 739. Other sealants may contain acetic acid, which is harmful to sensors and electronics.

## CHECKING EQUIPMENT

### CAUTION

Handle Microcell™ sets with care. Dropping, striking, etc. can damage the Microcells™.

### VISUAL CHECK

Visually inspect all equipment in the order, including Microcells™, junction boxes, Installation Kit, and insulation (if provided), to verify they were not damaged during shipment. If any item was damaged, contact Kistler-Morse® immediately for a replacement.

### FUNCTIONAL CHECK

Perform a functional check of the Microcells™ before installation to verify they were not damaged during shipment. Two methods of performing the check are described below.

### TESTING WITH A KISTLER-MORSE® TEST METER

The Kistler-Morse® Test Meter (Figure 2-1) is designed specifically to test Kistler-Morse® sensors. If you do not have a test meter, disregard this section and proceed to TESTING WITH A DIGITAL MULTIMETER (DMM).

### Note

The test meter display indicates a low battery or behaves erratically when the batteries are weak. When this occurs, replace the batteries before testing.

1. See Figure 2-1. Connect the Microcell™ red, white, and black wires to the corresponding test meter terminals. Place the Microcell™ on a stable surface.
2. Turn on the power to the test meter and set the Simulate/Test Switch to the Test position. Verify the no-load output is between +25mV and -25mV.
3. Repeat Steps 1 and 2 for each Microcell™. If the no-load output for any Microcell™ is outside these specifications:

- A. Proceed to TESTING WITH A DIGITAL MULTIMETER (DMM) to determine the resistance values for that Microcell™, **and**
- B. Contact Kistler-Morse® for assistance after determining the resistance values and before proceeding with installation.

**CAUTION**

Replace Micrcells™ in packing tubes until ready to install.

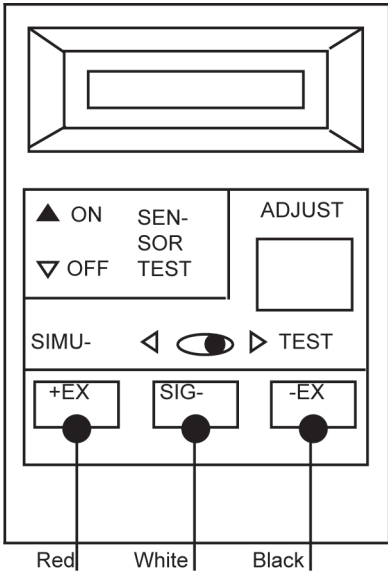

Figure 2-1. Kistler-Morse® Test Meter.

3. Put one DMM lead on the Microcell™ white wire and the other lead on the black wire. Place the Microcell™ on a stable surface. Verify the resistance is within the following limits:
  - 3" standardized Microcell™ (light blue cover): 8,300Ω - 8,700Ω
  - 2" standardized Microcell™ (dark blue cover): 1,800Ω - 2,200Ω
4. Repeat Steps 2 and 3 for each Microcell™. If either reading for any Microcell™ is outside these specifications, contact Kistler-Morse® for assistance before proceeding with installation.

**CAUTION**

Replace Micrcells™ in packing tubes until ready to install.

**TESTING WITH A DIGITAL MULTIMETER (DMM)**

Follow this procedure to test the Microcell™ sets if you do not have a Kistler-Morse® Test Meter or the readings using the Test Meter were outside the specifications:

1. Set the DMM resistance scale to accommodate a measured range up to 20,000Ω.
2. Put one DMM lead on the Microcell™ white wire and the other lead on the red wire. Place the Microcell™ on a stable surface. Verify the resistance is within the following limits:
  - 3" standardized Microcell™ (light blue cover): 8,300Ω - 8,700Ω
  - 2" standardized Microcell™ (dark blue cover): 1,800Ω - 2,200Ω



---

# CHAPTER 3. MICROCELL™ INSTALLATION ON VERTICAL COLUMN LEGS

## INTRODUCTION

Follow the instructions in this chapter only if installing Microcells™ on vertical column legs. This chapter describes the mounting locations, installation details, and wiring details for Microcells™ and junction boxes. Follow all instructions carefully to ensure proper system operation.

### **Note**

Do not mix different types of Microcells™ on one vessel. The three types (3" standardized, 3" non-standardized, and 2" standardized) are not interchangeable.

## MOUNTING LOCATIONS

Follow the procedures below to determine and mark Microcell™ mounting locations prior to beginning installation. Following these procedures will ensure optimal system performance. Consult Kistler-Morse® if special considerations prevent you from installing Microcells™ at the designated locations.

### **MICROCELL™ SETS**

#### **BEST PERFORMANCE**

See Figure 3-1. For best performance, Microcells™ are mounted in a rosette array — a vertical Microcell™ with a horizontal Microcell™ above it in a “T” configuration. A Microcell™ set consists of two rosette arrays (four Microcells™ total) mounted on opposite sides of a support leg, at the same elevation.

### **Note**

Best performance cannot be achieved if:

1. The leg is too narrow for the horizontal Microcell™ and its environmental cover, or
  2. Installation is on round legs.
- See STANDARD PERFORMANCE.

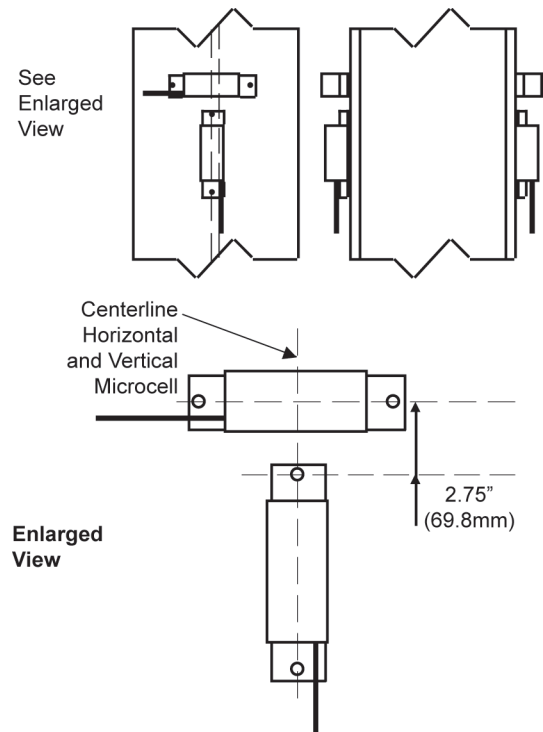

Figure 3-1. Microcell™ Rosette Array for Best Performance.

#### **STANDARD PERFORMANCE**

For standard performance, Microcells™ are mounted vertically. A Microcell™ set consists of two (2) Microcells™ mounted on opposite sides of a support leg, at the same elevation.

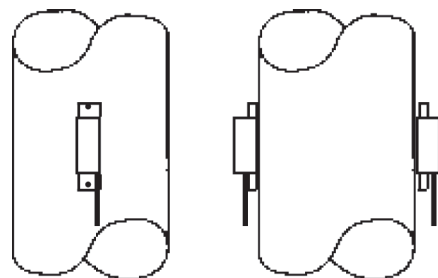
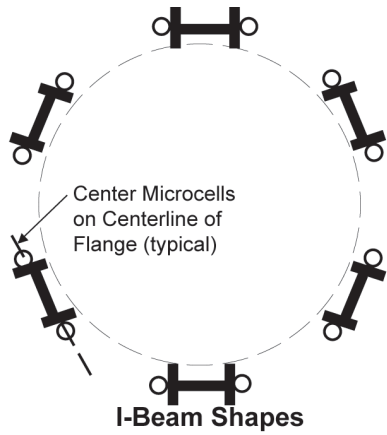
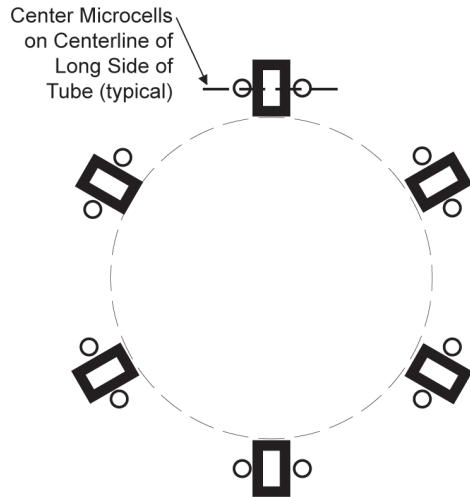

Figure 3-2. Vertical Microcell™ for Standard Performance.



**I-Beam Shapes**

○ = rosette array (1 vertical and 1 horizontal Microcell) or vertical Microcell  
 Note: Always place Microcells at center of flange, regardless of orientation of leg to vessel.



**Rectangular Tubes**

○ = rosette array (1 vertical and 1 horizontal Microcell) or vertical Microcell  
 Note: Always place Microcells at center of long side of tube, regardless of orientation of leg to vessel.

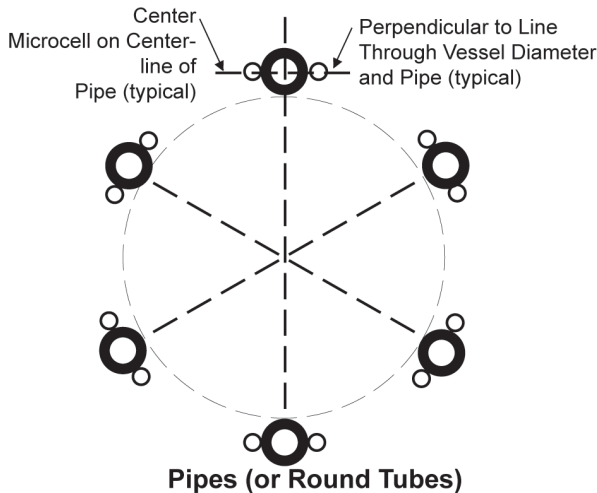

**Pipes (or Round Tubes)**

○ = 1 vertical Microcell

Figure 3-3. Microcell™ Mounting Arrangements on Legs.

## HORIZONTAL DISTRIBUTION OF MICROCELL™ SETS

Microcell™ sets are placed on each support leg. Refer to Figure 3-3 for the mounting locations for each shape.

## VERTICAL LOCATION OF MICROCELL™ SETS

### Note

Microcell™ locations may be adjusted up to 12 in (305mm) vertically to avoid obstacles. If adjusting locations, maintain the configuration of the Microcell™ set (i.e., if one Microcell™ in the set is moved from its ideal location, move the other(s) as well).

## COLUMN LEGS WITHOUT X-BRACES

See Figure 3-4.

If the free leg distance is between 12 in (305mm) and 11 ft (3.4m), mount the Microcell™ sets at mid-height of the free leg.

If the free leg distance is more than 11 ft (3.4m), mount the Microcell™ sets at 5 ft 6 in (1.7m) above the foundation.

If the free leg distance is less than 12 in (305mm), this is a special application situation. Consult Kistler-Morse® before proceeding further.

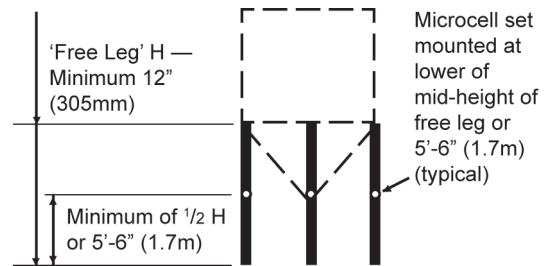

Figure 3-4. Vertical Location of Microcell™ Sets for Legs Without X-Braces.

## COLUMN LEGS WITH X-BRACES

See Figure 3-5.

If the free leg distance is 12 in (305mm) or more, mount the Microcell™ sets at mid-height of the free leg.

Measure the free leg between the bottom of the bottom X-brace or horizontal brace and the top of the foundation.

For an alternate location, measure the free leg between the top of the top X-brace or horizontal brace and the beam supporting the vessel.

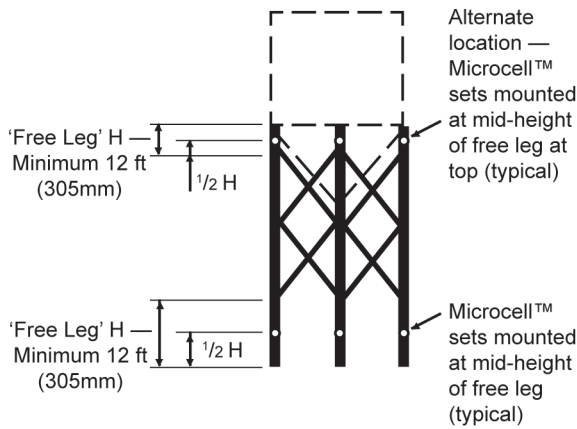

Figure 3-5. Vertical Location of Microcell™ Sets for Legs With Braces and with Free Leg Greater Than 12 in (305mm).

See Figure 3-6. If the free leg distance is less than 12 in (305mm), mount the Microcell™ sets at the mid-height between the lowest braces. When mounting between the braces, insulation around the adjacent braces is required for best performance. This insulation will reduce the effect of sun-induced stresses on the support metal.

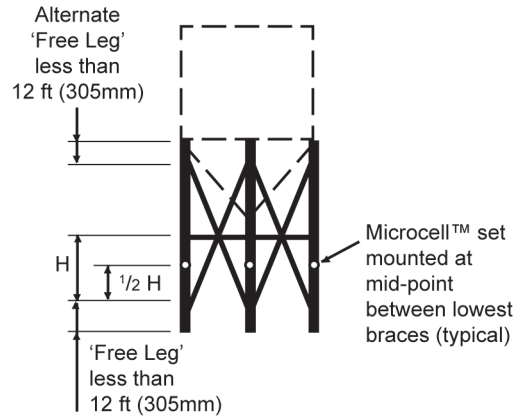
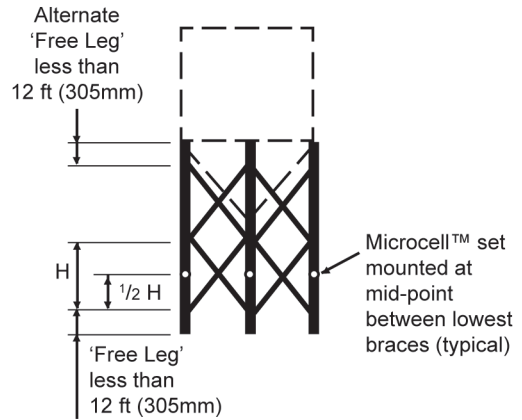

Figure 3-6. Vertical Location of Microcell™ Sets for Legs With Braces and with Free Leg Less Than 12 in (305mm).

## INSTALLING MICROCELL™ SETS

### Note

1. Use lubricating fluid (Relton RapidTap® Heavy Duty Cutting Fluid or equivalent) when drilling and tapping.
2. Drilling and tapping instructions assume metal thickness greater than  $\frac{3}{4}$ " (19mm). If the thickness is less, drill all the way through the metal and tap until cutting complete threads through the other side. Minimum metal thickness is 0.1875" (5mm), which provides six thread engagement.

### SURFACE PREPARATION

1. See Figure 3-7. At the center of the vertical Microcell™ mounting location, drill a  $\frac{3}{4}$ " (19mm) deep hole with the #29 drill bit. This produces the template mounting hole. Repeat for the horizontal Microcell™ (if applicable).
2. See Figure 3-7. Mark the surface preparation area for the vertical Microcell™ and horizontal Microcell™ (if applicable).
3. Attach the coarse grit sandpaper to the grinder. Remove heavy paint and rust with the grinder until a bare metal surface is achieved. Due to the use of coarse grit, the resulting surface is somewhat coarse.

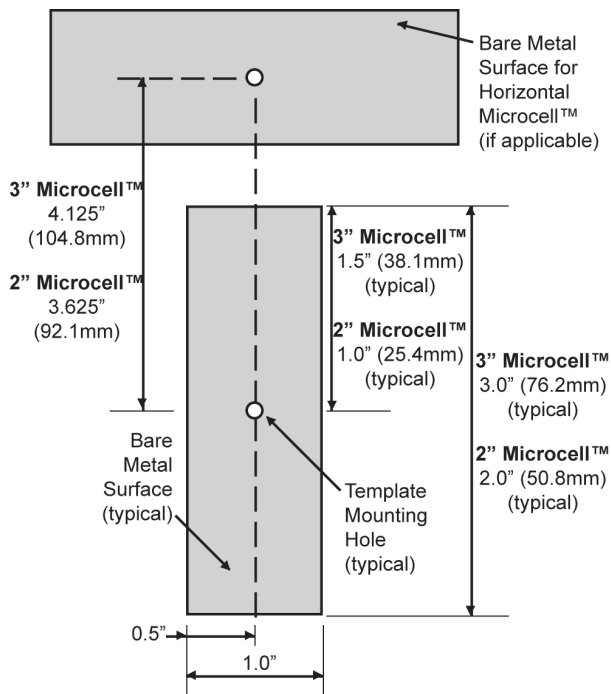

Figure 3-7. Prepared Mounting Surface.

4. Replace the coarse grit sandpaper with the fine grit sandpaper. Grind until the surface(s) is completely down to bare metal and smooth to the touch.

### Note

The Microcell™ must be mounted against smooth, bare metal. Remove all paint and rust from the area where the Microcell™ is to be fastened.

### DRILL AND TAP

1. Using the #8-32 tap, thread the template mounting hole for the vertical Microcell™ (drilled during Surface Preparation) to a minimum  $\frac{5}{8}$ " (16mm) depth, full threads. Remove any burrs from the hole.
2. See Figure 3-8. Position the drill template so the center hole lines up with the template mounting hole.
3. Fasten the drill template to the template mounting hole through the center hole, using the captive #8-32 socket head cap screw. Use a level to ensure correct orientation.
4. Using the #29 drill bit, drill two  $\frac{3}{4}$ " (19mm) deep holes in the leg through the template drill guides.

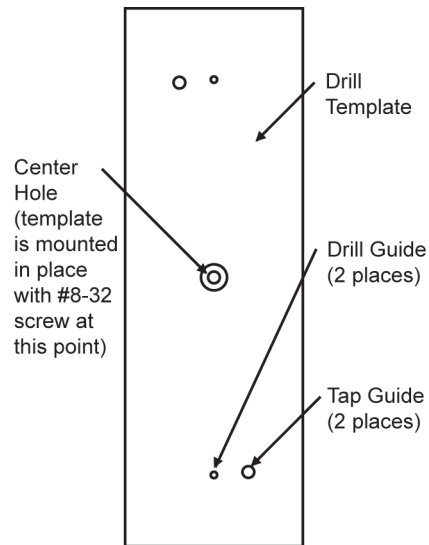

Note: For installation of a horizontal Microcell™ as part of a rosette array, the template is rotated 90°.

Figure 3-8. Drill and Tap Template.

- 
- Loosen the screw securing the template and rotate the template until the two tap guides line up with the drilled holes. Push the #8-32 tap into one of the tap guide holes to align the template. Retighten the screw securing the template.
  - Using the #8-32 tap, thread the two holes through the template tap guides. Tap to a minimum  $\frac{5}{8}$ " (16mm) depth, full threads. Remove the template from the leg.
  - If installing a rosette array, repeat Steps 1 through 6 for the horizontal Microcell™.
  - Remove burrs from all the holes created.

## MOUNTING MICROCELL™ SETS

### CAUTION

Do not install Microcells™ in the rain. Do not trap moisture under the environmental cover.

- Wipe down a 5 in by 2¼ in (127mm by 57mm) surface, centered on the template mounting hole, with degreaser. This cleans the bare metal and adjacent mounting surface for the environmental cover.
- Apply a thin coat of Kistler-Morse® rust inhibitor to the bare metal surface for the vertical Microcell™.

### CAUTION

Do not apply rust inhibitor beyond this area, or the environmental cover will not adhere properly.

- Connect the Microcell™ red, black, and white wires to the corresponding terminals on the Kistler-Morse® Test Meter. Turn on the power to the Test Meter and set the Simulate/Test Switch to the Test position.

### Note

If a Kistler-Morse® Test Meter is not available, refer to Appendix C (Alternate Method for Checking Output) before proceeding.

- With the cable end down, align a vertical Microcell™ with its mounting holes. Fasten the Microcell™ loosely to the leg using the two #8-32 x  $\frac{5}{8}$ " socket head cap screws and washers. **Do not tighten the screws.** If the voltage goes outside the range -100mV to +100mV, immediately loosen the screw(s).

### Note

3" Microcells™ for vertical and horizontal installation are slightly different. 3" Microcells™ for horizontal installation are labeled "Horizontal." 3" Microcells™ for vertical installation are not labeled.

### CAUTION

For proper installation, tighten each screw until the T-handle driver flexes in torsion ¼ turn past the point where the screw stops turning. Repeat this flexing procedure several times to ensure the screw is tight. When both screws are tight, the voltage must be in the range -100mV to +100mV. Follow the procedure in Steps 5 through 7 to achieve this goal.

- Using the T-handle driver, slowly tighten the top screw. While turning the T-handle driver, monitor the test meter carefully. If the voltage goes outside the range -100mV to +100mV while tightening, stop immediately and evaluate the following:
  - If the voltage jumped outside the range -100mV to +100mV, it may indicate a burr or rough surface. Remove the screws holding the Microcell™ to the leg. Check for and remove burrs and surface roughness (refer to SURFACE PREPARATION for removing surface roughness). Repeat Steps 1 through 5.
  - If the voltage gradually moved outside the range -100mV to +100mV, slowly loosen the screw until the voltage is within range again and proceed to Step 6.
- Repeat Step 5 for the bottom screw. If the voltage is outside the range -100mV to +100mV, attempt to bring the reading within range by loosening the screw being torqued, tightening the other screw, or some combination of loosening and tightening. If you have difficulty staying within the range, try turning each screw ¼ turn at a time until both screws are tightened.

## Note

If the following occurs while tightening screws, check Microcell™ resistance using a DMM (described in Problem 1 in Chapter 6):

- A. Voltage does not change or changes less than 25mV as you turn a screw, **or**
  - B. Voltage changes randomly as you turn a screw (i.e., not in a consistent direction).
7. To complete installation, ensure that both screws are tightened until the T-handle driver flexes in torsion, ¼ turn past the point where the screw stops turning, with this flexing procedure repeated several times to ensure the screw is tight, **and** the voltage is in the range -100mV to +100mV.
  8. Repeat Steps 1 through 7 for the horizontal Microcell™ (if applicable).
  9. Prior to installing the environmental cover(s), ensure the mating surface(s) on the leg is free of dirt and grease. Reclean if necessary, being careful not to remove the rust inhibitor on the bare metal.
  10. See Figure 3-9. Apply a generous bead of sealant to the inside flange of the environmental cover. Add extra sealant to the cable exit channel.
    - A. Align the environmental cover over the installed Microcell™, with the cable through the cover's exit channel.
    - B. Press the cover against the web, squeezing out the sealant around the edges. Be careful not to squeeze too much sealant out.
    - C. Use your finger to smooth the sealant around all edges and joints, eliminating areas where moisture may pool, especially along the top edge. Verify the sealant forms a continuous, watertight seal. Ensure the cable exit channel is completely sealed.
    - D. Repeat Step 10 for the horizontal Microcell™ (if applicable).

## CAUTION

**Only use Sikaflex 1A polyurethane sealant or Dow Corning RTV 738 or RTV 739.** Other sealants may contain acetic acid, which is harmful to sensors and electronics.

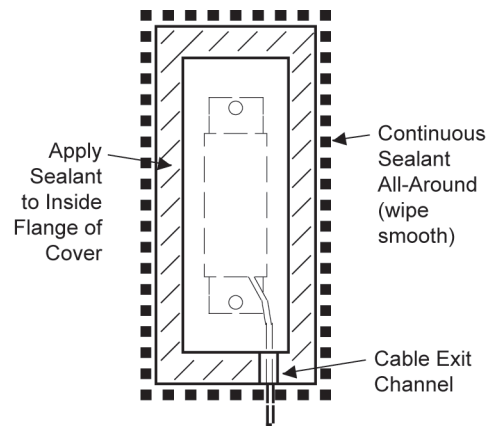

Figure 3-9. Environmental Cover.

11. If you created any holes that go completely through the support metal, spread sealant (Sikaflex 1A polyurethane sealant or Dow Corning RTV738 or RTV 739) over the open holes. Use your finger to press sealant into each hole.

## MOUNTING JUNCTION BOX

### MOUNTING LOCATION

Each junction box can be wired to a maximum of two Microcell™ sets (four Microcells™ total):

1. Microcell™ rosette arrays - the four Microcells™ on a support leg (two sets, each consisting of a vertical and a horizontal Microcell™) are wired to one junction box.
2. Vertical Microcells™ - one junction box can be wired to Microcells™ from two support legs (two Microcells™ on each support leg) if the legs are sufficiently close to each other to allow the Microcell™ cables to reach.

See Figure 3-10. Locate the junction box on the support leg web or on a brace. Vertically, locate junction boxes at a convenient height, approximately 4 ft (1.2m) from the ground. The exact location of the junction box is not critical, but ensure you have sufficient cable length and that a drip loop will be formed by the Microcell™ cables when wired to the junction box.



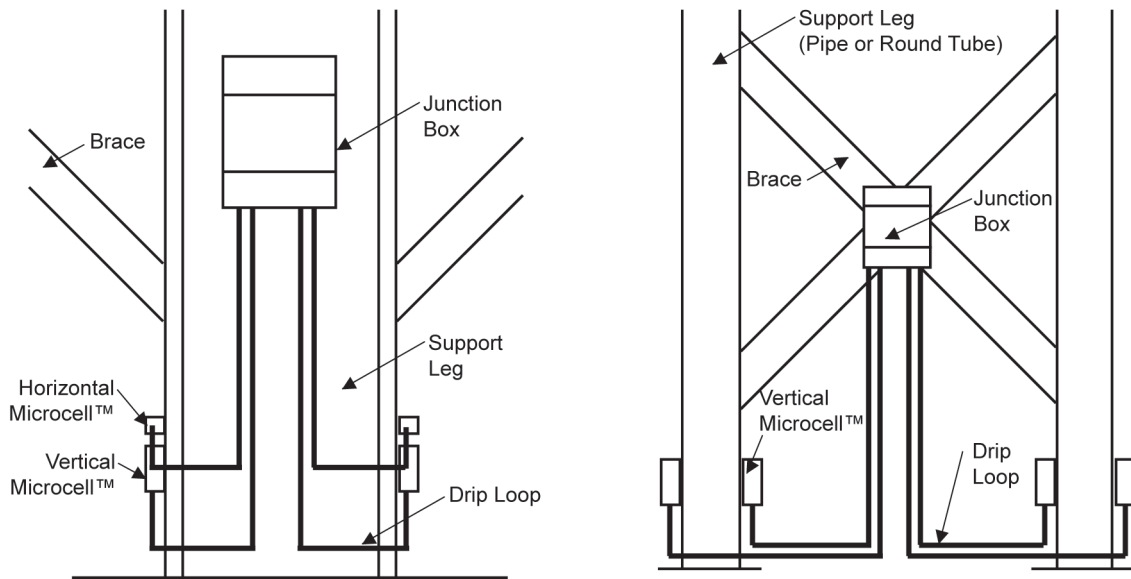

Figure 3-10. Possible Junction Box Mounting Locations.

## JUNCTION BOX INSTALLATION

### CAUTION

**Do not install junction boxes in the rain.**

Moisture in the junction box will cause corrosion and system errors.

### Note

Junction box mounting hardware is not supplied by Kistler-Morse®. Kistler-Morse® recommends #8-32 socket head cap screws and flat washers. The instructions below reflect this recommendation.

1. Remove the junction box cover.
2. See Figure 3-11. Hold the junction box at the previously marked mounting location. Mark the mounting holes. Mark the four outside mounting holes if mounting on a flat surface, such as an I-beam or rectangular tube. Mark the two center mounting holes if mounting on a curved surface, such as a pipe or round tube.
3. Drill and tap the mounting holes with a #29 drill bit and #8-32 tap.

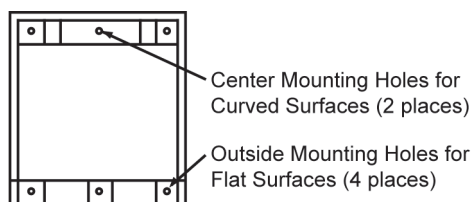

Figure 3-11. Junction Box Mounting.

4. Mount the junction box with #8-32 socket head cap screws and flat washers. Tighten the screws until snug. Replace the junction box cover and screws if not ready to begin wiring to ensure that no moisture enters the junction box.

## WIRING MICROCELLS™ TO JUNCTION BOX

### Note

- A. There are two versions of the junction box PCB. One version (63-1135-01) is used for vertical Microcells™. The other version (63-1135-03) is used for Microcell™ rosette arrays. Ensure you have the correct PCB in the junction box (See Figure 3-13).
- B. The four small holes in the bottom of the junction box are for wiring the Microcells™ to the junction box.

1. Remove the junction box cover.
2. See Figure 3-12. Place a plastic washer on a watertight fitting. Thread the Microcell™ cable through a cap and watertight fitting. Leave an adequate length of cable between the Microcell™ and fitting to provide a drip loop (See Figure 3-13).
3. Spread a generous bead of sealant around the sides of the watertight fitting.

**CAUTION**

Only use Sikaflex 1A polyurethane sealant or Dow Corning RTV 738 or RTV 739. Other sealants may contain acetic acid, which is harmful to sensors and electronics.

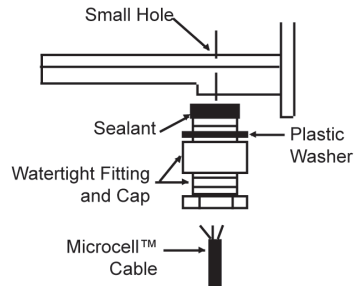
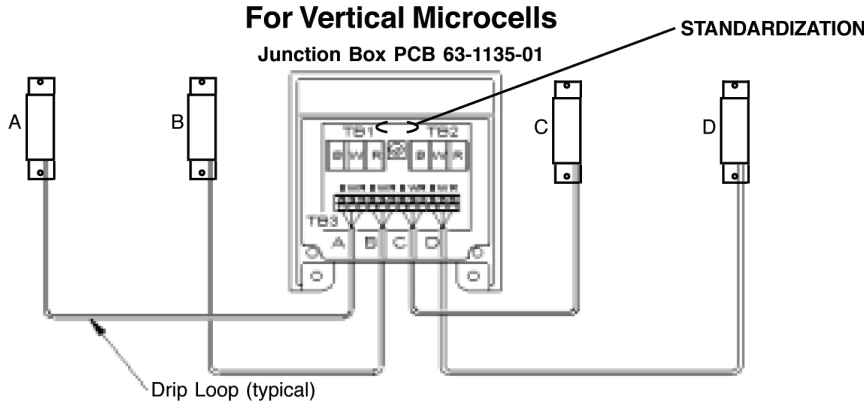
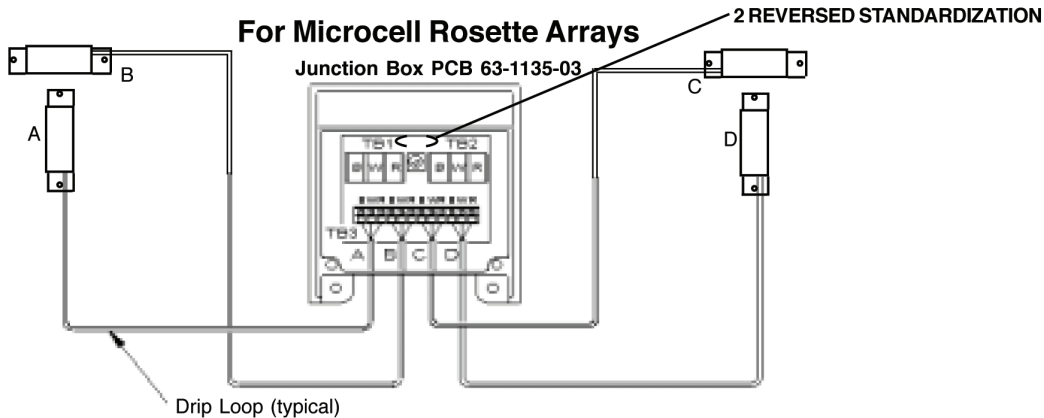

Figure 3-12. Inserting Microcell™ Cable Through Watertight Fitting and Cap



**Notes:**

- Verify that junction box PCB is 63-1135-01 (bottom center) and shows 'STANDARDIZATION' (top center).
- Microcells A and B are on one support leg.
- Microcells C and D are on another support leg. Microcells C and D can be wired as shown, or can be wired to their own junction box (terminals A and B) if desired.



**Notes:**

- Verify that junction box PCB is 63-1135-03 (bottom center) and shows '2 REVERSED STANDARDIZATION' (top center).
- Excitation for terminals B and C are reversed from terminals A and D. Wire each Microcell to its corresponding terminal to ensure proper system operation.
- Microcells A and B are in one rosette array — A is vertical and B is horizontal.
- Microcells C and D are in the other rosette array for the same leg — D is vertical and C is horizontal.

Figure 3-13. Wiring Microcells™ to Junction Box.

4. See Figure 3-13. In the bottom of the junction box, locate one of the four small holes closest to the terminal being used for that Microcell™. Screw the watertight fitting into the hole.



### Note

TB3 terminal block has 12 terminals to accommodate up to four Microcells™ (A, B, C, and D). Locate the terminal labeled for the Microcell™ you are wiring.

5. Estimate the required length of cable to the terminal strip, allowing a little extra for strain relief. Cut the excess cable.
6. Strip back 3 in (76mm) of the cable sheathing to expose the three wires inside. Strip back ¼" (6mm) of insulation from the end of each of the wires.
7. Connect the wires from the Microcell™ to the selected TB3 terminals; black wire to B terminal, white wire to W terminal, and red wire to R terminal.
8. Perform Steps 2 through 7 for each Microcell™ you wire to this junction box (up to four).
9. Spread a generous bead of sealant (Sikaflex 1A polyurethane sealant or Dow Corning RTV 738 or RTV 739) around the sides of the plug for each hole not being used. Screw a plug into each hole.
10. Replace the junction box cover and screws if not ready to begin wiring the junction boxes together to ensure that no moisture enters the junction box.

## WIRING JUNCTION BOXES TOGETHER AND TO SIGNAL PROCESSOR

There are two versions of the junction box enclosure. Both versions have four small holes for wiring Microcells™ to the junction box, as described previously. In addition, the junction box has one or two large holes:

1. One large hole for conduited installation. The large hole, which accommodates a ¾" conduit fitting, is for wiring the junction box to the other junction boxes and to the signal processor.
2. Two large holes for non-conduited installation. The two large holes, which are equipped with PG13.5 cable fittings, are for wiring the junction box to the other junction boxes and to the signal processor.

**Kistler-Morse® requires the use of cable trays for non-conduited installations.**

### Note

- A. The following procedure assumes the conduit/cable tray has been installed.
- B. Seal all conduit fittings against water entry. Install drain holes at the conduit's lowest elevation(s) to allow condensation to drain.
- C. Use Belden™ 3-conductor shielded interconnect cable or equivalent to wire junction boxes together and to the signal processor. For lengths up to 1,000 ft (305m), use 18 gauge Belden™ 8791 cable. For lengths from 1,000 ft to 2,000 ft (305m to 610m), use 16 gauge Belden™ 8618 cable.
- D. When wiring cable to junction box terminals, strip back 3 in (76mm) of cable sheathing to expose the 3-conductor wires and shield wire inside. Strip ¼" (6mm) of insulation from the end of each of the conductor wires.
- E. All wiring routed between the junction boxes and signal processor must be continuous with no splices.

### CAUTION

**Only use Sikaflex 1A polyurethane sealant or Dow Corning RTV 738 or RTV 739.** Other sealants may contain acetic acid, which is harmful to sensors and electronics.

1. Remove the junction box cover. For a conduited installation, install a conduit fitting in the large hole in the bottom of the junction box. For a non-conduited installation, See Figure 3-14. Spread a generous bead of sealant around the sides of the PG13.5 cable fittings. Install the fittings in the two large holes in the bottom of the junction box.

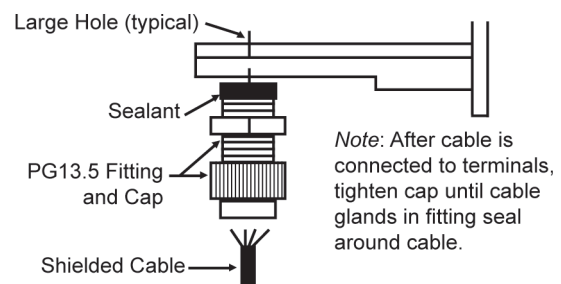

Figure 3-14. Inserting Shielded Interconnect Cable Through PG13.5 Fitting and Cap.

2. See Figure 3-15 (for a conduited installation) or Figure 3-16 (for a non-conduited installation). Route the 3-conductor cable through the fitting into the junction box farthest from the signal processor. Connect wires from the cable to the TB3 terminal in the junction box; black wire to B terminal, white wire to W terminal, and red wire to R terminal. Connect the cable shield wire to the Shield terminal between TB1 and TB2.
3. Route the cable through conduit/cable tray to the next junction box. Estimate the required length of cable to the terminal strip, allowing a little extra for strain relief. Cut the excess cable. Connect wires from the cable to the TB1 terminal in the junction box; black wire to the B terminal, white wire to the W terminal, and red wire to the R terminal. Connect the

cable shield wire to the the Shield terminal between TB1 and TB2.

4. Route another 3-conductor cable through the fitting into this junction box, and attach wires to the TB2 terminal; black wire to B terminal, white wire to W terminal, and red wire to R terminal. Connect the cable shield wire to the Shield terminal between TB1 and TB2.
5. Repeat Steps 3 and 4 until all junction boxes for the vessel are wired together.
6. Route the cable from the last junction box through conduit/cable tray to the signal processor. Refer to the signal processor manual for wiring the junction box to the signal processor. One vessel takes up one channel in the signal processor. The channel shows the average value from all the Microcells™ on the vessel supports.

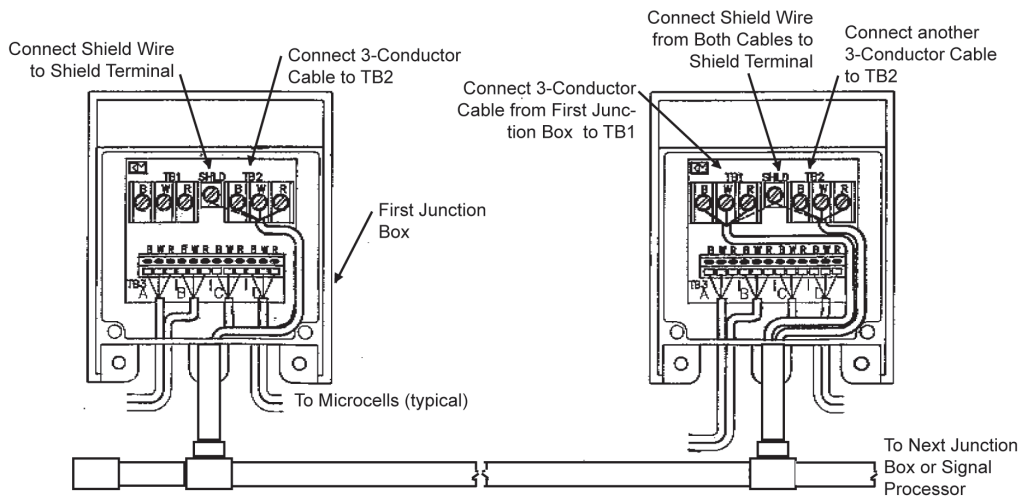

Figure 3-15. Wiring Junction Boxes Together - Conduited Installation.

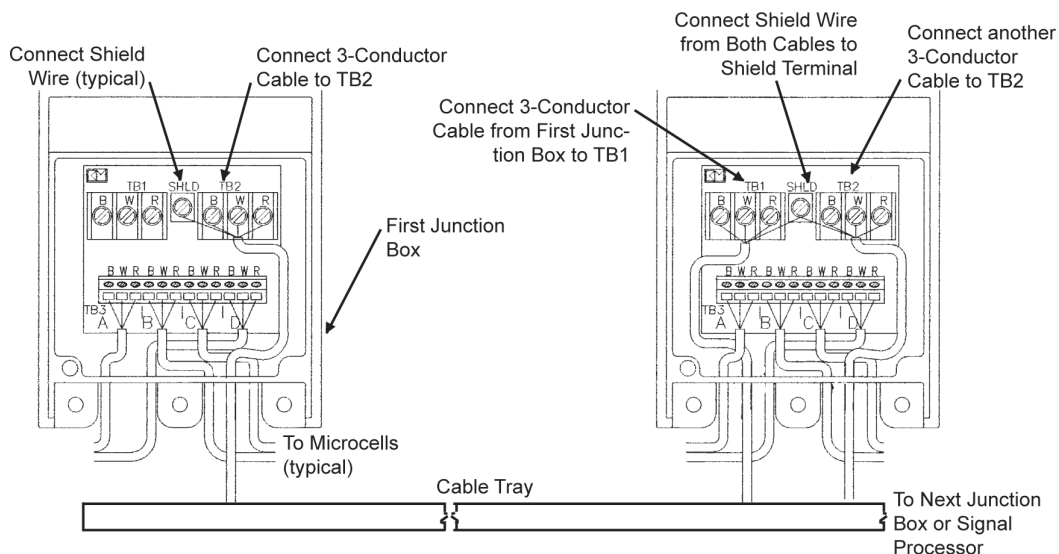

Figure 3-16. Wiring Junction Boxes Together - Non-Conduited Installation.

**Note**

Ground the cable shield only at the signal processor.

**INSTALLING INSULATION FOR OUTDOOR VESSELS (OPTIONAL)**

The sun affects the performance of an outdoor, bolt-on sensor system. The sun’s radiation heats the support metal unevenly, producing stresses in the supports that are unrelated to the weight of material in the vessel. The Microcell™ system minimizes errors associate with sun-induced stressed in several ways.

- A. Microcell™ sets and instrumentation of all support legs allow the system to subtract bending stresses resulting from uneven heating of supports.
- B. Microcell™ rosette arrays, where applicable, allow the system to subtract tensile/compressive stresses resulting from the heating of supports.

This configuration of the Microcell™ system minimizes errors associated with sun-induced stresses. However, if Microcells™ are installed on the legs between braces (See Figure 3-6), insulatio on each of the adjacent braces is required for best performance. This “brace wrap” insulation increases system accuracy by further reducing sun-induced stresses.

**INSULATION ORDER AND INSTALLATION EQUIPMENT**

The following are included with the insulation order (quantities are dependent of the number of braces):

- Brace wrap, 60 in by 85 in (1.5m by 2.2m)
- Tie wraps

The following are used for installation:

- Flexible tape measure
- Heavy-duty knife

**INSTALLING BRACE WRAP**

1. See Figure 3-17. Using a flexible tape measure, measure and record the wrap width required. allowing for a minimum 2 in (51mm) overlap.

2. See Figures 3-17 ad 3-18. Lay the wrap on a flat surface. Mark and cut it at the distance from Step 1.
3. See Figure 3-19. The goal is to cover most of the brace with wrap. Covering the brace where it crosses another brace in the middle is unnecessary. Depanding on the brace lenth, multiple sections of wrap may be required, with each section overlapping the one below it by a minimum of 2 in (51mm). Measure and record the space available for each section of wrap. If the space is more than 60 in (1.5m), skip Step 4 and proceed to Step 5.

**Note**

If a junction box is mounted within the area to be covered by wrap, cut the wrap so it does not cover the junction box.

4. From the top edge, measure and mark the wrap at the distance from Step 3. Cut the wrap where marked.
5. Position the wrap, starting at the bottom of the brace. Wrap it around the brace, overlapping the ends as shown in Figure 3-17. Fasten the wrap to the brace with four tie wraps.
6. Repeat Steps 2 through 5 for additional sections of wrap. Overlap each section of wrap by a minimum of 2 in (51mm).

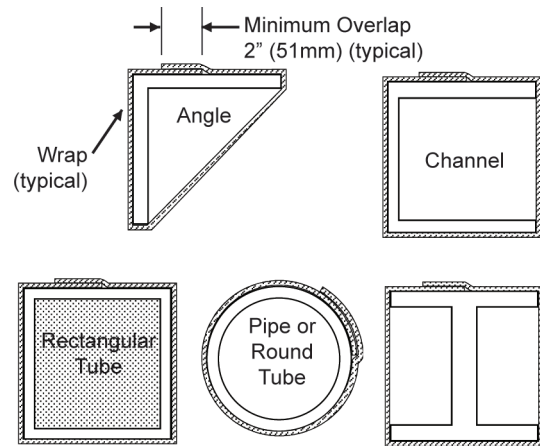

Figure 3-17. Wrap on Various Shapes.

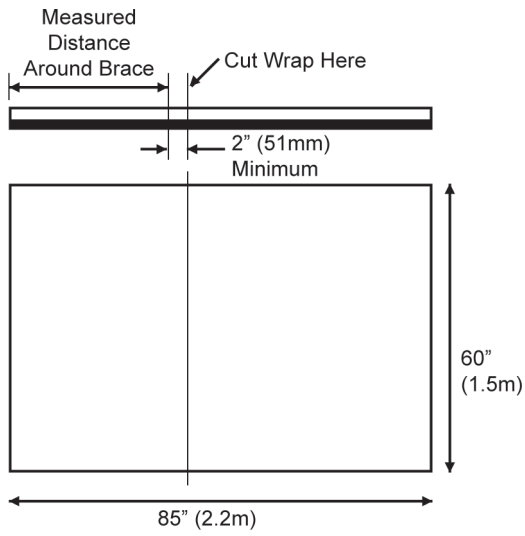
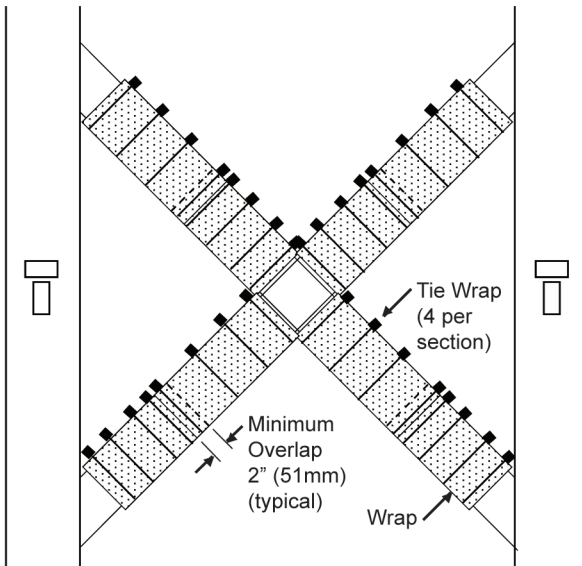

Figure 3-18. Cutting Wrap Width.



Note: Install wrap at bottom of brace first, working your way up brace so wrap overlaps as shown.

Figure 3-19. Installing Brace Wrap.

---

# CHAPTER 4. MICROCELL™ INSTALLATION ON HORIZONTAL BEAMS

## INTRODUCTION

Follow the instructions in this chapter only if installing Microcells™ on horizontal beams.

This chapter describes the mounting locations, installation details, and wiring details for Microcells™ and junction boxes. Follow all instructions carefully to ensure proper system operation.

### **Note**

Do not mix different types of Microcells™ on one vessel. The three types (3" standardized, 3" non-standardized, and 2" standardized) are not interchangeable.

## MOUNTING LOCATIONS

Follow the procedures below to determine and mark the Microcell™ mounting locations prior to beginning installation. Following these procedures will ensure optimal system performance. Consult Kistler-Morse® if special considerations prevents the installation of the Microcells™ at the designated locations.

### **MICROCELL™ SETS**

See Figure 4-1. Microcells™ are mounted on beams in a shear mounting set. A Microcell™ is set at a 45° angle to the horizontal with another Microcell™ set perpendicular to it on the other side of the support beam. Both Microcells™ are mounted with the lead wires on the "down" end.

### **DISTRIBUTION OF MICROCELL™ SETS**

The distribution of Microcell™ sets on beams is dependent on vessel support configuration. Figure 4-2 shows the distribution of sets for eight support configurations, varying from independent vessels to multiple vessels with common columns and beams. Note in all cases with common beams between multiple vessels, the common beams are not instrumented with Microcells™.

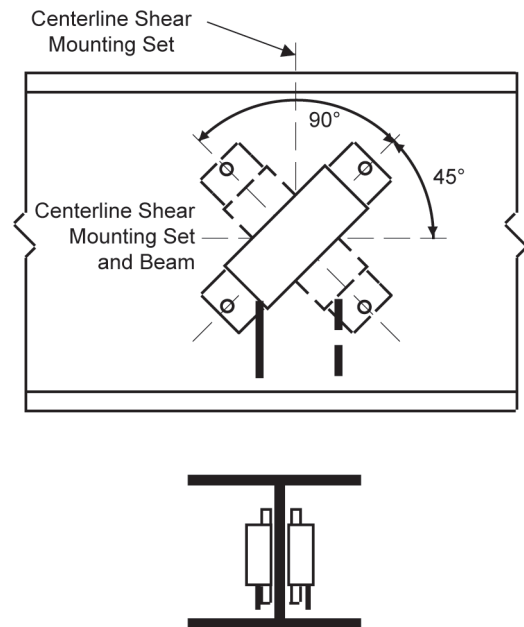
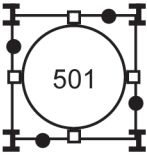
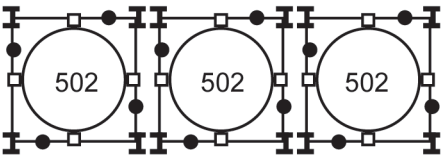
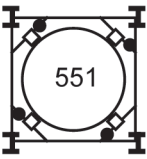
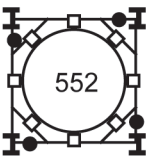
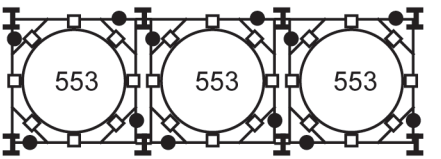
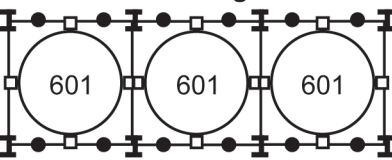
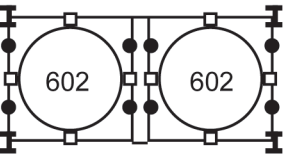
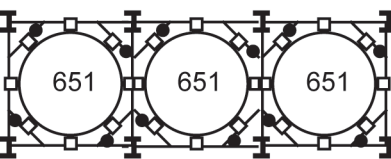

Figure 4-1. Microcell™ Shear Mounting Set.

	Description	# of Support Points for Each Vessel
<b>Series 500 — Independent Beams</b>		
	Single vessel — no diagonal beam supports	4
	Multiple vessels — no diagonal beam supports, no common beams or common vertical legs	4
	Single vessel — diagonal beam supports, weight supported by diagonal beams only	4
	Single vessel — diagonal beam supports, weight supported by horizontal and diagonal beams	8
	Multiple vessels — diagonal beam supports, weight supported by horizontal and diagonal beams, no common beams, common vertical legs	8
<b>Series 600 — Common Horizontal Lateral and/or Longitudinal Beams</b>		
	Multiple vessels — no diagonal beam supports, common internal lateral beams, common internal vertical legs	4
	Multiple vessels — no diagonal beam supports, independent internal lateral beams, common longitudinal beams	4
	Multiple vessels — diagonal beam supports, weight supported by horizontal and diagonal beams, common internal lateral beams, common internal vertical legs	8

**Notes:**

1. Illustrations for Series 501, 502, 551, 552, 553, and 651 show Microcells to the left of the load points. If obstructions prevent use of these locations, locate all Microcells to the right of the load points on the indicated beams.
2. If your application differs from the above, contact Kistler-Morse for application assistance.



Legend:	
	= vertical leg
	= vessel support point
	= mounting location for Microcell™ set

Figure 4-2. Microcell™ Mounting Locations.



Figures 4-3, 4-4, and 4-5 show the location of a Microcell™ set on a beam. The ideal location is midway between the vessel support bracket and the support column (or supporting beam). This places the shear mounting set away from joints and load points. The minimum distance between the load point and the support column or beam is 18 in (457mm). If less space is available, this is a special application. Consult Kistler-Morse® before proceeding further.

The top of Microcell™ A points toward the load point from the vessel, putting the Microcell™ in compression when the load is applied. Microcell™ B is mounted on the other side of the web, directly behind and at a 90° angle to Microcell™ A. The top of Microcell™ B points away from the load point, putting the Microcell™ in tension when the load is applied. There is no physical difference in Microcells™ A and B; the designations relate to how to wire the Microcells™ to the junction box.

**Note**

Microcell™ locations may be adjusted up to 12 in (305mm) in any direction to avoid obstacles. If adjusting locations, maintain the configuration of the set (i.e., if you move one Microcell™ in the set from its ideal location, move the other Microcell™ as well).

See Figure 4-5. If a second Microcell™ set is placed on a beam (Series 601 and 602), the Microcells™ are labeled C and D (pointing toward the load point).

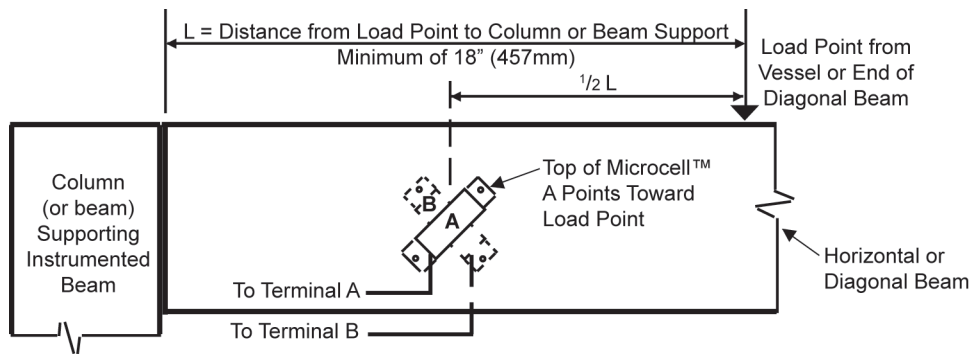

Figure 4-3. Placement of Microcell™ Set to the Left of Load Point.

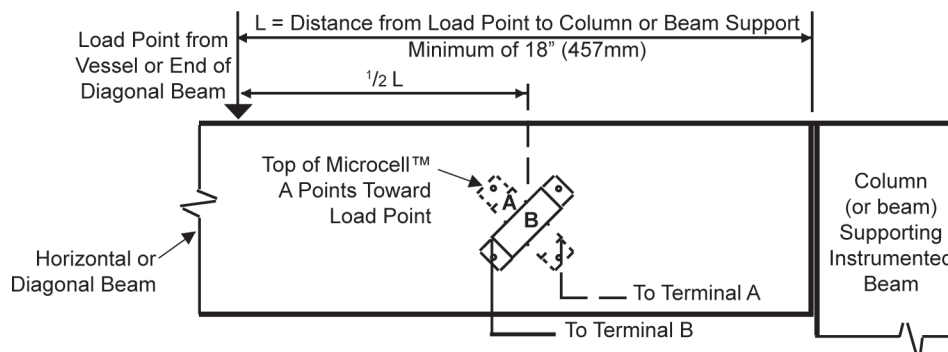

Figure 4-4. Placement of Microcell™ Set to the Right of Load Point.

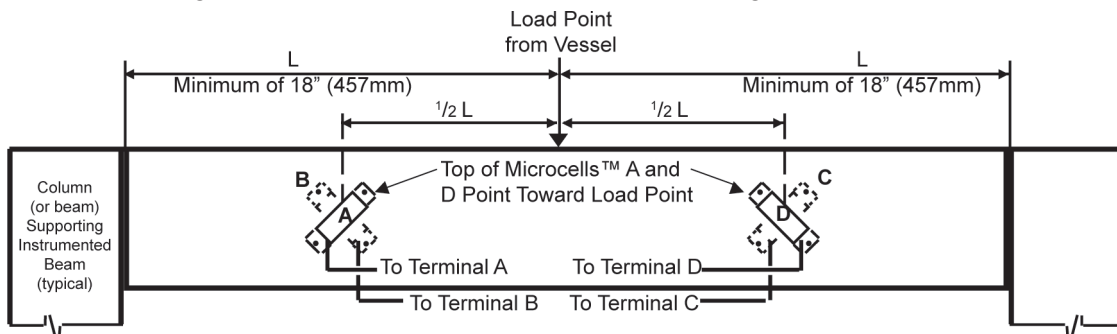

Figure 4-4. Placement of Two Microcell™ Sets on a Beam (Series 601 and 602).

## INSTALLING MICROCELL™ SETS

### Note

1. Procedures below refer to Microcells™ A and B, but also apply to Microcells™ C and D (if applicable to installation).
2. Use lubricating fluid (Relton RapidTap® Heavy Duty Cutting Fluid or equivalent) when drilling and tapping.
3. Drilling and tapping instructions assume metal thickness greater than 3/4" (19mm). If the thickness is less, drill all the way through the metal and tap until cutting complete threads through the other side. Minimum metal thickness is 0.1875" (5mm), which provides six thread engagement.

### SURFACE PREPARATION

1. See Figure 4-6. At the center of the Microcell™ mounting location, drill all the way through the web with the #29 drill bit. This produces the template mounting hole.
2. See Figure 4-6. Mark the surface preparation area for Microcell™ A. Repeat for Microcell™ B on the other side of the web.
3. Attach the coarse grit sandpaper to the grinder. Remove heavy paint and rust with the grinder until a bare metal surface is achieved for Microcell™ A. Using this grit of sandpaper will cause the surface to be somewhat coarse. Repeat for Microcell™ B.
4. Replace the coarse grit sandpaper with the fine grit sandpaper. Grind until the surface is completely down to bare metal and smooth to the touch for Microcell™ A. Repeat for Microcell™ B.

### Note

The Microcell™ must be mounted against smooth, bare metal. Remove all paint and rust from the area where the Microcell™ is to be fastened.

### DRILL AND TAP

1. Using the #8-32 tap, thread the template mounting hole (drilled during SURFACE PREPARATION) until the tap is cutting complete threads through the other side. Remove any burrs from the hole.

2. See Figure 4-7. Starting with the location of Microcell™ A, fasten the drill template to the template mounting hole through the center hole, using the captive #8-32 socket head cap screw. Use a level to ensure correct orientation (45° angle to the horizontal).
3. Using the #29 drill bit, drill two 3/4" (19mm) deep holes in the web through the template drill guides.
4. Loosen the screw securing the template and rotate the template until the two tap guides line up with the drilled holes. Push the #8-32 tap into one of the tap guide holes to align the template. Retighten the screw securing the template.
5. Using the #8-32 tap, thread the holes through the template tap guides. Tap to a minimum 5/8" (16mm) depth, full threads. Remove the template from the web.
6. Repeat Steps 2 through 5 for Microcell™ B on the other side of the web.
7. Remove burrs from all of the holes created.

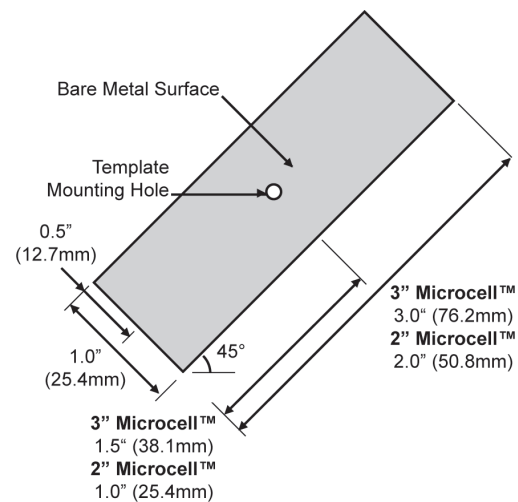

Figure 4-6. Prepared Mounting Surface.

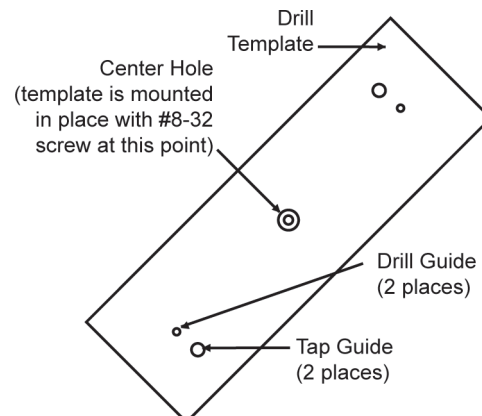

Figure 4-7. Drill and Tap Template.



---

## MOUNTING MICROCELL™ SETS

### CAUTION

Do not install Microcells™ in the rain. Do not trap moisture under the environmental cover of the Microcell™.

1. Mark two small pieces of masking tape “A.” Place one piece of tape on the plastic body of a Microcell™ and one piece near the end of the Microcell™ cable. Repeat for the other Microcell™, labeling it “B.”
2. Wipe down a 5 in x 2¼ in (127mm x 57mm) surface, centered on the template mounting hole, with degreaser. This cleans the bare metal and adjacent mounting surface for the environmental cover.
3. Apply a thin coat of Kistler-Morse® rust inhibitor to the bare metal surface for Microcell™ A.

### Note

Do not apply rust inhibitor beyond this area or the environmental cover will not adhere properly.

4. Connect the Microcell™ red, black, and white wires to the corresponding terminals on the Kistler-Morse® Test Meter. Turn on the power to the meter and set the Simulate/Test Switch to the Test position.

### Note

If a Kistler-Morse® Test Meter is not available, refer to Appendix C (Alternate Method for Checking Output) before proceeding with Step 5.

5. With the cable end down, align Microcell™ A with the mounting holes, ensuring that the top of Microcell™ A faces toward the vessel load point. Fasten the Microcell™ loosely to the web using the two #8-32 x 5/8” socket head cap screws and washers. Do not tighten the screws. If the voltage goes outside the range of -100mV to +100mV, immediately loosen the screw(s).

### CAUTION

For proper installation, tighten each screw until the T-handle driver flexes in torsion ¼ turn past the point where the screw stops turning.

Repeat this flexing procedure several times to ensure the screw is tight. When both screws are tight, the voltages must be in the range of -100mV to +100mV. Follow the procedure in Steps 6 through 8 to achieve this goal.

6. Using the T-handle driver, slowly tighten the top screw. While turning the T-handle driver, monitor the test meter carefully. If the voltage goes outside the range of -100mV to +100mV while tightening, stop immediately and evaluate the following:
  - A. If the voltage jumped outside the range of -100mV to +100mV, it may indicate a burr or rough surface. Remove the screws holding the Microcell™ to the web. Check for and remove burrs and surface roughness (refer to SURFACE PREPARATION for removing surface roughness). Repeat Steps 1 through 6.
  - B. If the voltage gradually moved outside the range of -100mV to +100mV, slowly loosen the screw until the voltage is within the range again and proceed to Step 7.
7. Repeat Step 6 for the bottom screw. If the voltage is outside the range of -100mV to +100mV, attempt to bring the reading within range by loosening the screw being torqued, tightening the other screw, or some combination of loosening and tightening. If you have difficulty staying within the range, try turning each screw ¼ turn at a time until both screws are tightened.

### Note

If the following occurs while tightening screws, check Microcell™ resistance using a DMM (described in Problem 1 in Chapter 6):

- A. Voltage does not change or changes less than 25mV as you turn a screw, **or**
- B. Voltage changes randomly as you turn a screw (i.e., not in a consistent direction).

8. To complete installation, ensure that both screws are tightened until the T-handle driver flexes in torsion, ¼ turn past the point where the screw stops turning, with this flexing procedure repeated several times to ensure the screw is tight, and the voltage is in the range -100mV to +100mV.
9. Repeat Steps 2 through 8 to install Microcell™ B on the other side of the web.
10. Prior to installing the environmental cover, ensure the mating surface on the web is free of dirt and grease. Reclean if necessary, being careful not to remove the rust inhibitor on the bare metal.
11. See Figure 4-8. Apply a generous bead of sealant to the inside flange of the environmental cover. Add extra sealant to the cable exit channel.
  - A. Align the environmental cover over the installed Microcell™ A, with the cable through the cover's exit channel.
  - B. Press the cover against the web, squeezing out the sealant around the edges. Be careful not to squeeze too much sealant out.
  - C. Use your finger to smooth the sealant around all edges and joints, eliminating areas where moisture may pool, especially along the top edge. Verify the sealant forms a continuous, watertight seal. Ensure the cable exit channel is completely sealed.
  - D. Repeat Step 11 for Microcell™ B.

**CAUTION**

**Only use Sikaflex 1A polyurethane sealant or Dow Corning RTV 738 or RTV 739.** Other sealants may contain acetic acid, which is harmful to sensors and electronics.

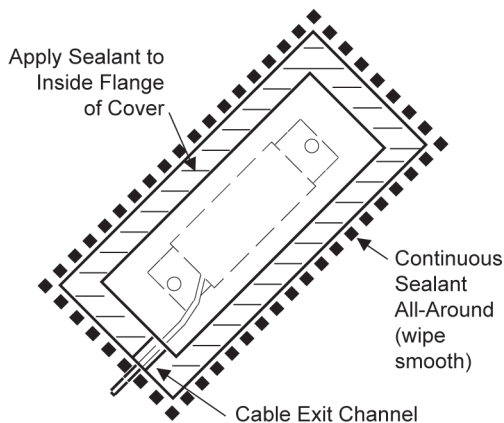

Figure 4-8. Environmental Cover.

12. If you created any holes that go completely through the web, spread sealant (Sikaflex 1A polyurethane sealant or Dow Corning RTV738 or RTV 739) over the open holes. Use your finger to press sealant into each hole.

**MOUNTING JUNCTION BOX**

**MOUNTING LOCATION**

Each junction box can be wired to a maximum of two Microcell™ sets (four Microcells™ total):

1. One set of Microcells™ on a beam; both Microcells™ are wired to one junction box.
2. Two sets of Microcells™ on a beam; all four Microcells™ are wired to one junction box if the sets are sufficiently close to each other to allow the Microcell™ cables to reach the junction box.

See Figures 4-9 and 4-19. Locate the junction box on the instrumented beam or on the supporting column or horizontal beam. Ensure you have sufficient cable length and that a drip loop will be formed by the Microcell™ cables when wired to the junction box.

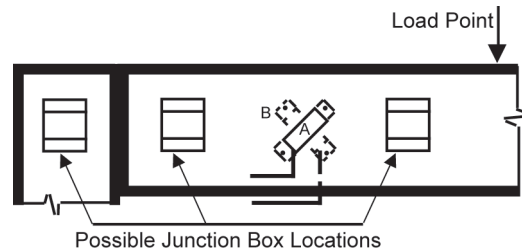

Figure 4-9. Junction Box Location - Two Microcells™ Per Junction Box.

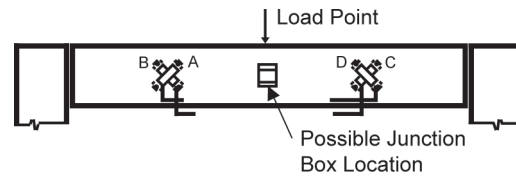

Figure 4-9. Junction Box Location - Four Microcells™ Per Junction Box.

**JUNCTION BOX INSTALLATION**

**CAUTION**

**Do not install junction boxes in the rain.** Moisture in the junction box will cause corrosion and system errors.

## Note

Junction box mounting hardware is not supplied by Kistler-Morse®. Kistler-Morse® recommends #8-32 socket head cap screws and flat washers. The instructions below reflect this recommendation.

1. Remove the junction box cover.
2. See Figure 4-11. Hold the junction box at the previously marked mounting location. Mark the mounting holes.
3. Drill and tap the mounting holes with a #29 drill bit and #8-32 tap.
4. Mount the junction box with #8-32 socket head cap screws and flat washers. Tighten the screws until snug. Replace the junction box cover and screws if not ready to begin wiring to ensure that no moisture enters the junction box.

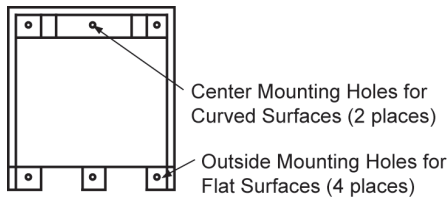

Figure 4-11. Junction Box Mounting.

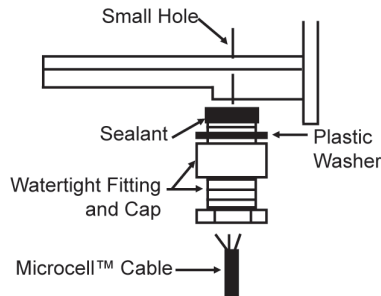
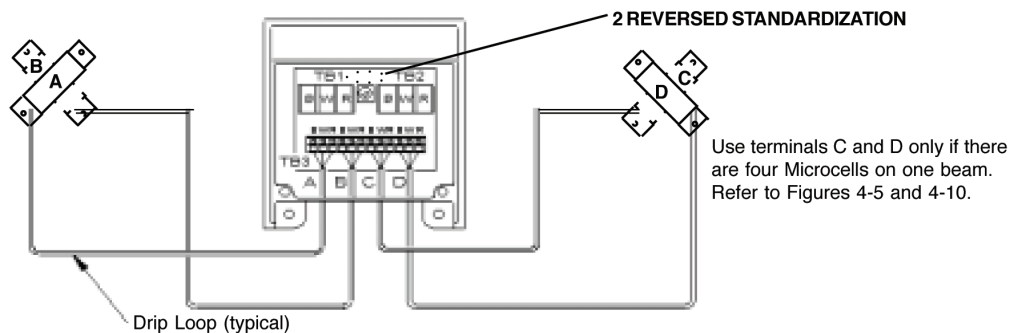

Figure 4-12. Inserting Microcell™ Cable Through Watertight Fitting and Cap.



### Notes:

- Verify that Junction Box PCB is 63-1135-03 (bottom center) and shows '2 REVERSED STANDARDIZATION' (top center).
- Excitation for terminals B and C are reversed from terminals A and D. Wire each Microcell to its corresponding terminal to ensure proper system operation.
- The top of Microcells A and D point toward the vessel load point.

Figure 4-13. Wiring Microcells™ to Junction Box.

## WIRING MICROCELL™ SETS TO JUNCTION BOX

### Note

- A. Junction box PCB 63-1135-03 is used for Microcell™ sets on beams. **Ensure you have this PCB in the junction box (See Figure 4-13).**
- B. The four small holes in the bottom of the junction box are for wiring the Microcells™ to the junction box.

1. Remove the junction box cover.
2. See Figure 4-12. Place a plastic washer on a watertight fitting. Thread the Microcell™ cable through a cap and watertight fitting. Leave an adequate length of cable between the Microcell™ and fitting to provide a drip loop (See Figure 4-13).
3. Spread a generous bead of sealant around the sides of the watertight fitting.

### CAUTION

**Only use Sikaflex 1A polyurethane sealant or Dow Corning RTV 738 or RTV 739.** Other sealants may contain acetic acid, which is harmful to sensors and electronics.

4. See Figure 4-13. In the bottom of the junction box, locate one of the four small holes closest to the terminal being used for that Microcell™. Screw the watertight fitting into the hole.

---

**Note**

TB3 terminal block has 12 terminals to accommodate up to four Microcells™ (two shear sets). Wire Microcell™ A to terminal A and Microcell™ B to terminal B. If there are four Microcells™ on one beam, wire Microcell™ C to terminal C and Microcell™ D to terminal D.

5. Estimate the required length of cable to the terminal strip, allowing a little extra for strain relief. Cut the excess cable.
6. Strip back 3 in (76mm) of the cable sheathing to expose the three wires inside. Strip back ¼" (6mm) of insulation from the end of each of the wires.
7. Connect the wires from the Microcell™ to the selected TB3 terminals; black wire to B terminal, white wire to W terminal, and red wire to R terminal.
8. Perform Steps 2 through 7 for each Microcell™ you wire to this junction box (up to four).
9. Spread a generous bead of sealant (Sikaflex 1A polyurethane sealant or Dow Corning RTV 738 or RTV 739) around the sides of the plug for each hole not being used. Screw a plug into each hole.
10. Replace the junction box cover and screws if not ready to begin wiring the junction boxes together to ensure that no moisture enters the junction box.

## **WIRING JUNCTION BOXES TOGETHER AND TO SIGNAL PROCESSOR**

There are two versions of the junction box enclosure. Both versions have four small holes for wiring Microcells™ to the junction box, as described previously. In addition, the junction box has one or two large holes:

1. One large hole for conduited installation. The large hole, which accommodates a ¾" conduit fitting, is for wiring the junction box to the other junction boxes and to the signal processor.

2. Two large holes for non-conduited installation. The two large holes, which are equipped with PG13.5 cable fittings, are for wiring the junction box to the other junction boxes and to the signal processor.  
**Kistler-Morse® requires the use of cable trays for non-conduited installations.**

**Note**

- A. The following procedure assumes the conduit/cable tray has been installed.
- B. Seal all conduit fittings against water entry. Install drain holes at the conduit's lowest elevation(s) to allow condensation to drain.
- C. Use Belden™ 3-conductor shielded interconnect cable or equivalent to wire junction boxes together and to the signal processor. For lengths up to 1,000 ft (305m), use 18 gauge Belden™ 8791 cable. For lengths from 1,000 ft to 2,000 ft (305m to 610m), use 16 gauge Belden™ 8618 cable.
- D. When wiring cable to junction box terminals, strip back 3 in (76mm) of cable sheathing to expose the 3-conductor wires and shield wire inside. Strip ¼" (6mm) of insulation from the end of each of the conductor wires.
- E. All wiring routed between the junction boxes and signal processor must be continuous with no splices.

**CAUTION**

**Only use Sikaflex 1A polyurethane sealant or Dow Corning RTV 738 or RTV 739. Other sealants may contain acetic acid, which is harmful to sensors and electronics.**

1. Remove the junction box cover.  
For a conduited installation, install a conduit fitting in the large hole in the bottom of the junction box.  
For a non-conduited installation, See Figure 4-14. Spread a generous bead of sealant around the sides of the PG13.5 cable fittings. Install the fittings in the two large holes in the bottom of the junction box.

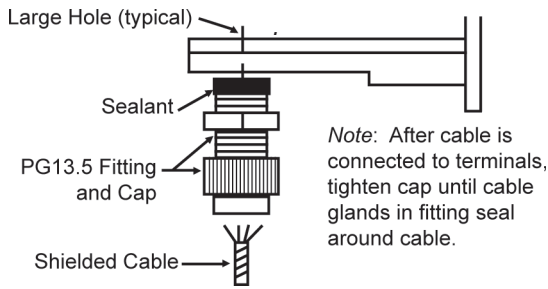

Figure 3-14. Inserting Shielded Interconnect Cable Through PG13.5 Fitting and Cap.

2. See Figure 4-15 (for a conduited installation) or Figure 4-16 (for a non-conduited installation). Route the 3-conductor cable through the fitting into the junction box farthest from the signal processor. Connect wires from the cable to the TB3 terminal in the junction box; black wire to B terminal, white wire to W terminal, and red wire to R terminal. Connect the cable shield wire to the Shield terminal between TB1 and TB2.
3. Route the cable through conduit/cable tray to the next junction box. Estimate the required length of cable to the terminal strip, allowing a little extra for strain relief. Cut

the excess cable. Connect wires from the cable to the TB1 terminal in the junction box; black wire to the B terminal, white wire to the W terminal, and red wire to the R terminal. Connect the cable shield wire to the the Shield terminal between TB1 and TB2.

4. Route another 3-conductor cable through the fitting into this junction box, and attach wires to the TB2 terminal; black wire to B terminal, white wire to W terminal, and red wire to R terminal. Connect the cable shield wire to the Shield terminal between TB1 and TB2.
5. Repeat Steps 3 and 4 until all junction boxes for the vessel are wired together.
6. Route the cable from the last junction box through conduit/cable tray to the signal processor. Refer to the signal processor manual for wiring the junction box to the signal processor. One vessel takes up one channel in the signal processor. The channel shows the average value from all the Microcells™ on the vessel supports.

**Note**

Ground the cable shield only at the signal processor.

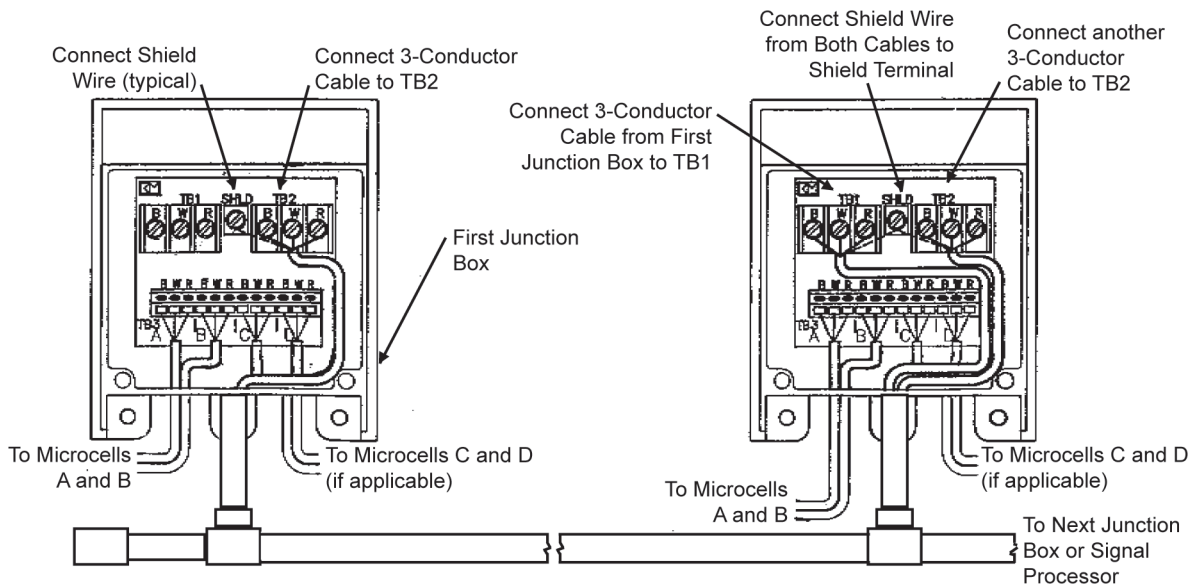

Figure 4-15. Wiring Junction Boxes Together - Conduited Installation.

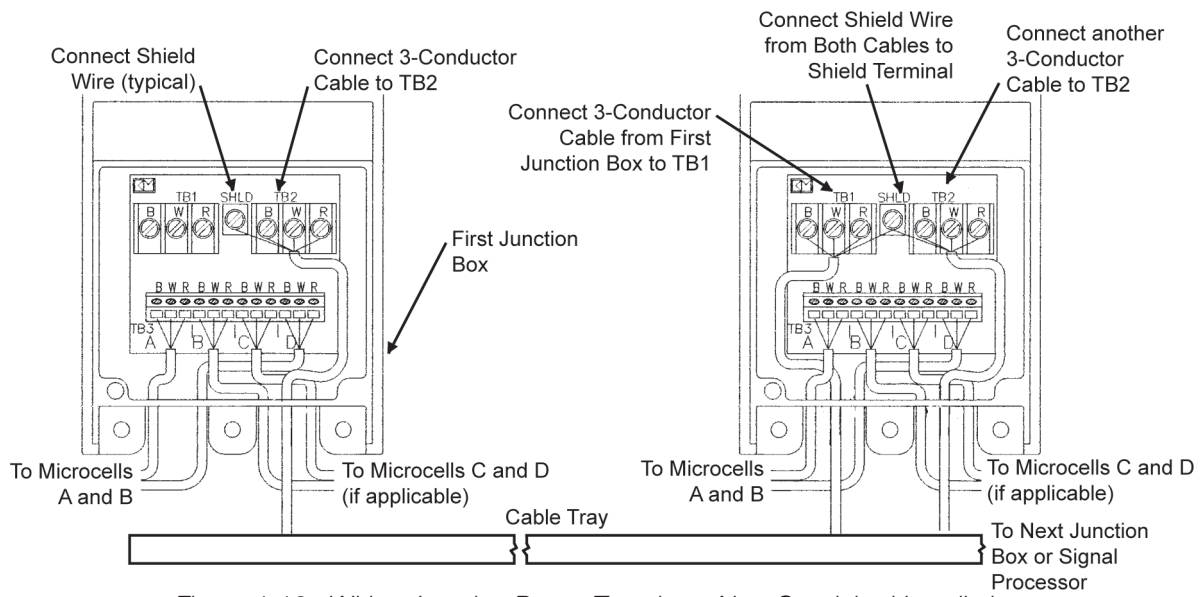

Figure 4-16. Wiring Junction Boxes Together - Non-Conducted Installation.



---

# CHAPTER 5. SYSTEM CALIBRATION

## INTRODUCTION

This chapter describes general procedures for calibrating the Microcell™ system. Before calibrating, you must install a signal processor. Refer to the signal processor manual for the procedures to input calibration parameters.

There are two calibration methods:

- A. Live Load Calibration — Set LO span and HI span while moving material into or out of the vessel. This is the preferred method.
- B. Manual Calibration — Set scale factor counts, scale factor weight, and zero calibration value without moving material. This method is less accurate than live load calibration.

A live load calibration requires you to move a known quantity of material into or out of the vessel while performing the procedure. The quantity of material moved must be at least 25% of the vessel's total capacity to provide best accuracy. Live load calibration is also based on the material weight currently in the vessel.

Manual Calibration allows you to start using the system as soon as Microcells™, junction boxes, and signal processor are installed and wired, even if you cannot move any (or enough) material now. Manual Calibration values are based on system parameters, including sensor sensitivity, vessel support stress, and signal processor A/D converter sensitivity. These values are known, can be calculated, or can be obtained from the signal processor. Manual Calibration is also based on the material weight currently in the vessel.

Note that Manual Calibration does not take into account the *actual* response to changes in weight. Theoretically, a change in weight results in a

proportional change in digital counts. However, the structure's actual response to load and interaction with piping, catwalks, roof, discharge chutes, etc. prevents the system from achieving theoretical values. Manual Calibration is a good start, but to obtain the highest accuracy, perform a live load calibration when scheduling permits you to move material into or out of the vessel.

The following sections provide procedures for performing live load and Manual Calibrations.

## LIVE LOAD CALIBRATION

Live load calibration can be performed by adding **or** removing a known quantity of material from the vessel. The quantity of material moved must be at least 25% of the vessel's total capacity. The procedures for both live load calibration methods follow.

### **ADDING A KNOWN QUANTITY OF MATERIAL**

See Figure 5-1.

1. Record the current live load.
2. Input *LO Span*:  $LO\ Span = \text{current live load}$ .
3. Add known quantity of material to the vessel. Ensure all material has stopped moving before proceeding.
4. Input *HI Span*:  $HI\ Span = LO\ Span + \text{Added Weight}$ .

#### **Example**

You are using Microcells™ to monitor a vessel. The vessel contains 50,000 lb of material and can hold a maximum of 200,000 lb. You plan to add 60,000 lb of material (which is greater than 25% of 200,000 lb).

Following the Live Load Calibration procedure:

1. Current live load = 50,000 lb
2.  $LO\ Span = \text{current live load} = 50,000\ \text{lb}$
3. Add 60,000 lb of material.
4.  $HI\ Span = LO\ Span + \text{Added Weight}$   
 $= 50,000\ \text{lb} + 60,000\ \text{lb}$

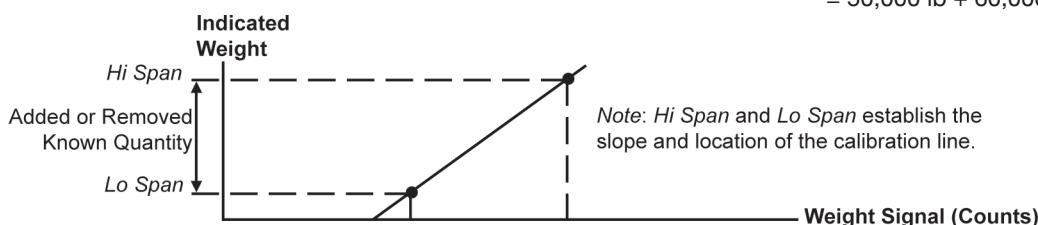

Figure 5-1. Live Load Calibration by Adding or Removing a Known Quantity of Material.

## REMOVING A KNOWN QUANTITY OF MATERIAL

See Figure 5-1.

1. Record the current live load.
2. Input *HI Span*:  $HI\ Span = \text{current live load}$ .
3. Remove known quantity of material to the vessel. Ensure all material has stopped moving before proceeding.
4. Input *LO Span*:  $LO\ Span = HI\ Span - \text{Removed Weight}$ .

### Example

You are using Microcells™ to monitor a vessel. The vessel contains 110,000 lb of material and can hold a maximum of 200,000 lb. You plan to remove 60,000 lb of material (which is greater than 25% of 200,000 lb).

Following the Live Load Calibration procedure:

1. Current live load = 110,000 lb
2. *HI Span* = current live load = 110,000 lb
3. Remove 60,000 lb of material.
4. *LO Span* = *HI Span* - Removed Weight  
= 110,000 lb - 60,000 lb  
= 50,000 lb

## MANUAL CALIBRATION

### Note

The Kistler-Morse® SVS-2000™ signal processor performs a manual calibration automatically with *Quick Config*.

See Figure 5-2.

1. Refer to the signal processor manual to determine how to obtain the A/D converter sensitivity, expressed in Counts/mV. Record this value.
2. Record the Microcell™ sensitivity (S). Sensitivity for Microcells™ on legs and beams are shown in Table 5-1.
3. Refer to the Application Data Form for the vessel (contact Kistler-Morse® for an additional copy if needed). Record the maximum live load and the stress.
4. Record the current live load in the vessel.

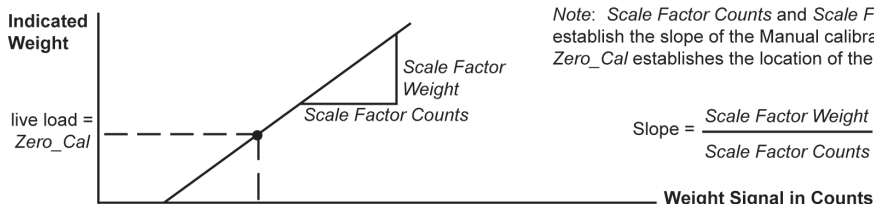

Figure 5-2. Manual Calibration Line.

5. Calculate the Manual Calibration values:  
Scale Factor Weight = maximum live load  
Scale Factor Counts =  $S * \text{Counts/mV} * \text{Stress}$   
Zero\_Cal = current live load
6. Refer to the signal processor manual to input the calibration values.

### Example 1. Microcells™ on Vertical Legs.

You are using 3" Microcells™ in rosette arrays on vertical column legs. The vessel has four W10x39 carbon steel legs and no braces. The vessel currently contains 50,000 lb of material and can hold a maximum of 200,000 lb.

Following the procedure:

1. Counts/mV = 699.05 (from signal processor)
2.  $S = 0.045\ \text{mV/psi}$  (From Table 5-1, for legs with rosette array)
3. From the Application Data Form, the maximum live load is 200,000 lb. The stress is 4348 psi.
4. Current live load = 50,000 lb
5. Calculate the values for the calibration:  
Scale Factor Weight = Maximum live load = 200,000 lb  
Scale Factor Counts =  $S * \text{Counts/mV} * \text{Stress}$   
=  $0.045\ \text{mV/psi} * 699.05\ \text{Counts/mV} * 4348\ \text{psi}$   
= 136,776 Counts  
Zero\_Cal = current live load = 50,000 lb

### Example 2. Microcells™ on Beams.

You are using 3" Microcells™ on beams. The vessel has four W10x39 carbon steel horizontal beams and four W10 x 39 carbon steel diagonal beams. The Microcells™ are on the horizontal beams only. The vessel currently contains 50,000 lb of material and can hold a maximum of 150,000 lb.

Following the procedure:

1. Counts/mV = 699.05 (from signal processor)
2.  $S = 0.070\ \text{mV/psi}$  (From Table 5-1, for beams)
3. From the Application Data Form, the maximum live load is 150,000 lb. The stress is 5929 psi.
4. Current live load = 50,000 lb
5. Calculate the values for the calibration:  
Scale Factor Weight = Maximum live load = 150,000 lb  
Scale Factor Counts =  $S * \text{Counts/mV} * \text{Stress}$   
=  $0.070\ \text{mV/psi} * 699.05\ \text{Counts/mV} * 5929\ \text{psi}$   
= 290,127 Counts  
Zero\_Cal = current live load = 50,000 lb

	Vertical Column Legs		Horizontal Beams
	Vertical Microcells	Rosette Array	
<b>3" Microcell™</b>			
Carbon Steel	0.070 (99.6)	0.045 (64.0)	0.070 (99.6)
Aluminum	0.154 (219)	0.100 (142)	0.154 (219)
Stainless Steel	0.058 (82.5)	0.038 (54.1)	0.058 (82.5)
<b>2" Microcell™</b>			
Carbon Steel	0.056 (79.7)	0.036 (51.2)	0.056 (79.7)

Note: Units are mV/psi [mV/(kg/mm²)].

Note: Scale Factor Counts and Scale Factor Weight establish the slope of the Manual calibration line, while Zero\_Cal establishes the location of the line.

$$\text{Slope} = \frac{\text{Scale Factor Weight}}{\text{Scale Factor Counts}}$$



---

## CHAPTER 6. TROUBLESHOOTING

This chapter describes some common problems you may encounter while using Microcells™. For each problem, one or more possible explanations are listed. An indication of when the problem is likely to be noticed and suggested solutions are provided for each explanation.

### **PROBLEM 1. SMALL AMPLITUDE CHANGES OR ERRATIC FLUCTUATIONS IN DISPLAY READINGS.**

#### **EXPLANATION**

Small amplitude drift or oscillation, with peak-to-peak disturbance of 0.1% to 0.3% of full scale, is normal.

#### **Problem Likely to be Noticed**

Shortly after initial installation.

#### **Solution**

Reduce or eliminate drift or oscillation by setting “count by” and “averaging” appropriately on signal processor (refer to signal processor manual).

#### **EXPLANATION**

Fluctuations can be caused by moisture in cable conduit, junction boxes, or printed circuit boards (PCBs).

#### **Problem Likely to be Noticed**

On system that previously functioned correctly.

#### **Solution**

Check conduit, junction boxes, and PCBs for water contamination. Find water entry source and correct problem. Dry with a hair dryer. Remove/replace corroded parts and materials.

#### **CAUTION**

**If using a sealant to eliminate water entry, use Sikaflex 1A polyurethane sealant or Dow Corning RTV 738 or RTV 739.** Other sealants may contain acetic acid, which is harmful to sensors and electronics.

#### **EXPLANATION**

Fluctuations can be caused by a damaged Microcell™.

#### **Problem Likely to be Noticed**

Shortly after initial installation or on system that previously functioned correctly.

#### **Solution**

Using Digital Multimeter (DMM) or ohmmeter, check resistance for individual Microcells™:

1. Set meter resistance scale to accommodate measured range up to 20,000Ω.
2. Remove one Microcell™ wire from junction box terminal TB3.
3. Put one DMM lead on the white wire of the Microcell™ and other DMM lead on the red wire of the Microcell™. Record resistance and verify it is within following limits:
  - A. 3” standardized Microcell™ (light blue cover) - between 8,300Ω and 8,700Ω
  - B. 2” Microcell™ and 3” non-standardized Microcell™ (dark blue cover) - between 1,800Ω and 2,200Ω

If reading is outside this range, the Microcell™ is damaged and must be replaced.

4. Put one DMM lead on the white wire of the Microcell™ and other DMM lead on the black wire of the Microcell™. Record resistance and verify it is within following limits:
    - A. 3” standardized Microcell™ (light blue cover) - between 8,300Ω and 8,700Ω
    - B. 2” Microcell™ and 3” non-standardized Microcell™ (dark blue cover) - between 1,800Ω and 2,200Ω
- If reading is outside this range, the Microcell™ is damaged and must be replaced.
5. Verify readings from Steps 3 and 4 are within 140Ω of each other. If not, the Microcell™ is damaged and must be replaced.
  6. Repeat Steps 2 through 5 for each suspect Microcell™, until damaged Microcell™ is located.

---

## EXPLANATION

Fluctuations in readings can be caused by short to ground.

### Problem Likely to be Noticed

Shortly after initial installation or on system that previously functioned correctly.

### Solution

Using a Digital Multimeter (DMM) or ohmmeter, check for shorts to ground:

1. Set meter resistance scale to accommodate maximum measured range.
2. Disconnect junction box wires from signal processor.
3. With one lead to earth ground and other lead to white wire, check resistance on disconnected junction box wires:
  - A. If reading is less than infinite (i.e., there is resistance), a short is indicated; proceed to Step 4 to identify location.
  - B. If no short is indicated, investigate other explanations for problem.
4. Starting with junction box closest to signal processor in daisy chain, disconnect wires connecting junction box to the other junction boxes. With one lead to earth ground and other lead to white wire, check resistance on wires leading from junction box:
  - A. If reading is less than infinite (i.e., there is resistance), short is indicated; proceed to Step 5 to further identify location.
  - B. If no short is indicated, proceed to next junction box in daisy chain. Disconnect wires connecting it to other junction boxes and check resistances. Repeat for each junction box down chain until short is located; proceed to Step 5.
5. Disconnect Microcell™ wires for one Microcell™ from above-identified junction box. With one lead to earth ground and other lead to white wire, check resistance on disconnected Microcell™ wires:
  - A. If reading is less than infinite (i.e., there is resistance), short is indicated. Replace shorted Microcell™.

- B. If no short is indicated, disconnect next Microcell™ wires from junction box and check resistances. Repeat for each Microcell™ wired to junction box until short is located. Replace the shorted Microcell™.

## EXPLANATION

Fluctuations in readings can be caused by problems with signal processor.

### Problem Likely to be Noticed

Shortly after initial installation or on system that previously functioned correctly.

### Solution

Check signal processor excitation voltage and incoming AC voltage for accuracy and stability (refer to signal processor manual).

## PROBLEM 2. REPEATABLE DRIFT OVER A 24-HOUR PERIOD.

## EXPLANATION

Periodic drift is most likely caused by thermal expansion of vessel or vessel's supports due to the sun's radiation or a vessel's response to its own heating cycles.

### Problem Likely to be Noticed

Shortly after initial installation or on system that previously functioned correctly in cool or overcast weather.

### Solution

1. If periodic drift is outside specifications (Appendix A), contact Kistler-Morse®.
2. For Microcells™ installed on vertical column legs, if drift is within specifications but you want to reduce it further, install Kistler-Morse® insulation. Contact Kistler-Morse® to order insulation. Installation details are included in Chapter 3 (Microcell™ Installation on Vertical Column Legs).
3. If keeping long-term records, take readings at the same time each day to minimize error.

---

### **PROBLEM 3. SUDDEN CHANGE IN DISPLAY READING OR SYSTEM REQUIRES FREQUENT CALIBRATION.**

#### **EXPLANATION**

A single broken Microcell™ can cause indicated weight to shift up or down by a large amount, up to 100% of full-scale live load.

#### **Problem Likely to be Noticed**

On system that previously functioned correctly.

#### **Solution**

Check voltage outputs of individual Microcells™ (see TESTING WITH A KISTLER-MORSE® TEST METER in Chapter 2). Voltage should be between -500mV and +500 mV on installed Microcells™. If not, check Microcell™ resistance as described in Problem 1.

#### **EXPLANATION**

Slipping of Microcell™ can cause indicated weight to shift suddenly.

#### **Problem Likely to be Noticed**

Shortly after initial installation.

#### **Solution**

If broken Microcell™ is not indicated, perform the following procedure:

1. Carefully remove environmental cover from Microcell™.
2. Tighten Microcell™ #8-32 socket head cap screws, following procedure in appropriate Microcell™ Installation Chapter (Chapter 3 for vertical column legs or Chapter 4 for horizontal beams).
3. Replace environmental cover on Microcell™. Follow procedure in appropriate chapter on installation.

#### **CAUTION**

Only use Sikaflex 1A polyurethane sealant or Dow Corning RTV 738 or RTV 739. Other sealants may contain acetic acid, which is harmful to sensors and electronics.

#### **EXPLANATION**

Sudden change in weight reading can be caused by problems with signal processor.

#### **Problem Likely to be Noticed**

Shortly after initial installation or on system that previously functioned correctly.

#### **Solution**

Check signal processor excitation voltage and incoming AC voltage for accuracy and stability (refer to signal processor manual).

---

# APPENDIX A. MICROCELL™ SPECIFICATIONS.

## MECHANICAL

Stress Level		
3" Microcell™	Maximum	10,000 psi (7.0kg/mm <sup>2</sup> )
	Recommended*	5,000 psi ± 2,500 psi (3.5kg/mm <sup>2</sup> ± 1.75kg/mm <sup>2</sup> )
2" Microcell™	Maximum	15,000 psi (10.5kg/mm <sup>2</sup> )
	Recommended*	7,500 psi ± 3,750 psi (5.3kg/mm <sup>2</sup> ± 2.6kg/mm <sup>2</sup> )
Fatigue Life		> 20 million cycles; load and unload at 0 to 5,000 psi (0kg/mm <sup>2</sup> to 3.5kg/mm <sup>2</sup> )

\*Consult factory for application assistance for stress levels outside the recommended range.

## ELECTRICAL

Excitation Voltage		Standard 12VDC, ±5%; maximum 30VDC
Excitation Current at 12V		4.0mA at 0° F (-18° C) to 2.7mA at 100° F (+38° C)
Insulation Resistance		2kΩ
Strain Gage to Sensor Frame Breakdown Voltage		> 500VDC
Red-to-White and Black-to-White Resistance		
3" Microcell™		Standardized: 8.50kΩ ± 200Ω at 70° F (21° C) Non-Standardized: 2.0kΩ ± 200Ω at 70° F (21° C)
2" Microcell™		2.0kΩ ± 200Ω at 70° F (21° C)

## OUTPUT FOR 12V EXCITATION

Sensitivity		
3" Microcell™		70mV ± 1%/1,000 psi (70mV ± 1%/0.7kg/mm <sup>2</sup> )
2" Microcell™		56mV ± 1%/1,000 psi (56mV ± 1%/0.7kg/mm <sup>2</sup> )
Zero-Strain Output		0mV ± 25mV
Non-linearity		±0.1% of full-scale output
Repeatability and Hysteresis		0.05% of full-scale output
Output Impedance		
3" Microcell™		Standardized: 7.5kΩ ± 75Ω at 70° F (21° C) Non-Standardized: 1.0kΩ ± 100Ω at 70° F (21° C)
2" Microcell™		1kΩ ± 100Ω at 70° F (21° C)

## ENVIRONMENTAL

Rating		Designed for rugged, outdoor applications
Temperature Range		
Operational		-30° F to +150° F (-34° C to +66° C)
Storage		-30° F to +150° F (-34° C to +66° C)
Compensated		Standard: 0° F to +100° F (-18° C to +38° C) Mid: +50° F to +150° F (+10° C to +66° C)
Temperature Effects		
Sensitivity Change		0.02%/° F (0.036%/° C), in compensated temperature range
Zero Shift		±5mV/100° F (±5mV/56° C), in compensated temperature range

## PHYSICAL

Weight		3 oz (90g)
Cable		3-conductor, 22 gauge, unshielded
Steel Base		AISI 1018 carbon steel matched to A36
Aluminum Base		Custom — consult factory
Stainless Steel Base		Custom — consult factory
Cable Length		5.5 ft (1.7m)
Size		See Reference Dimensions

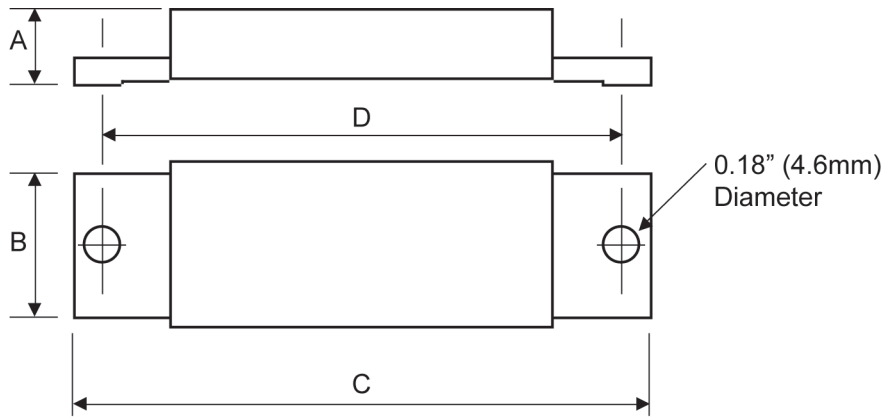

REFERENCE DIMENSIONS		
	3-inch Microcell	2-inch Microcell
<b>A</b>	.375" (9.52mm)	.375" (9.52mm)
<b>B</b>	0.75" (19.0mm)	0.75" (19.0mm)
<b>C</b>	3.00" (76.2mm)	2.00" (50.8mm)
<b>D</b>	2.75" (69.8mm)	1.75" (44.4mm)

*Note:* These dimensions are for reference only. Use the Microcell drill template to locate, drill, and tap the mounting holes.

---

## APPENDIX B. GLOSSARY

### **CALIBRATION CURVE**

A graph of load versus output. Typically, it is a straight line and relates live load to a voltage or digital count output.

### **LIVE LOAD**

The weight of the material to be measured; in other words, the weight of the contents of the vessel.

### **HYSTERESIS**

The maximum difference between sensor readings for the same applied load, with one reading obtained by increasing the load from zero and the other reading obtained by decreasing the load from the rated load. It is usually expressed as a percentage of the rated load.

### **NON-LINEARITY**

The maximum deviation of the sensor calibration curve from a straight line between zero load and the rated load.

### **REPEATABILITY**

The maximum difference between sensor readings for repeated loadings under identical loading and environmental conditions.

### **SENSITIVITY**

The ratio of the change in electrical output to the change in load or stress.

### **SIGNAL PROCESSOR**

The electronic firmware and software box connected to a sensor (such as a Microcell™) or transducer array. If it is augmented with software, the first stage of the signal processor is an A/D converter. A signal processor generally has provisions for most, if not all, of the following:

1. Excitation voltage applies to each of the sensors/transducers in the network.
2. Adjustable zero calibration.
3. Adjustable scale factor.
4. Long-distance signal transmission options, such as 4-20mA or serial transmission.
5. Set Point (commonly referred to as a contact closure) to provide a discrete indication that a specific point has been reached.

6. Some type of indicator or display, such as numerals, needle movement, discrete LED array, etc.

---

## APPENDIX C. ALTERNATE METHOD FOR CHECKING OUTPUT

If you do not have a Kistler-Morse® Test Meter, use a Digital Multimeter (DMM) to monitor the voltage output of each Microcell™ during installation. Set up the DMM as described below and then follow the installation procedure for mounting the Microcell™.

### Note

The junction box must be mounted and wired to the signal processor and powered up before proceeding with the following procedure. See previous sections about Mounting Junction Box, Wiring Microcells™ to Junction Box, and Wiring Junction Boxes Together and to Signal Processor before continuing.

1. See Figure C-1. Connect the red wire from the Microcell™ cable to the R terminal on terminal block TB3 in the junction box. Connect the black wire to the B terminal on TB3.
2. Connect the signal (+) probe of the DMM to the white wire from the Microcell™ cable. DO NOT connect the white wire to the terminal block.
3. Connect the common (-) probe of the DMM to TP1 on the junction box circuit board. If a test point is not present, connect the common probe to the lead of either R1 or R2 nearest the TB2 terminal strip.
4. Set a voltage range on the DMM that will accommodate a measured range of  $\pm 1V$ .
5. Complete installation of the Microcell™, using the DMM to monitor the voltage output as you tighten the screws. See Mounting the Microcell™ for your installation.

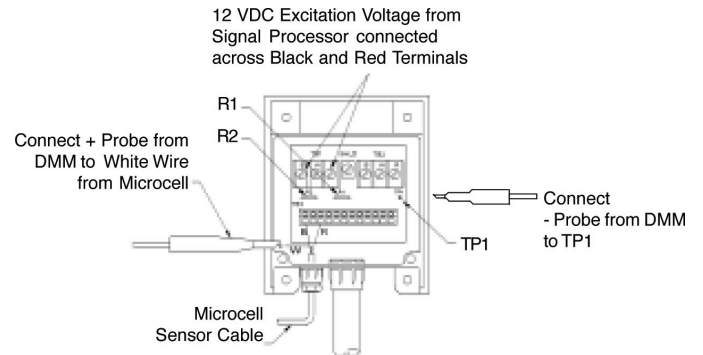

Figure C-1. Using DMM to Monitor Voltage Output.

---

## APPENDIX D. SPARE PARTS RECOMMENDATIONS

Kistler-Morse® recommends the purchase and maintenance of the following minimum number of spare parts/tools for the Microcell™ system:

### 1 Extra per Vessel

Microcell™ Sensor, each complete with:

Sensor

Environmental Cover

#8-32 socket head cap screws (2)

#8 hardened flat washers (2)

### 1 Extra per Plant

T-handle driver

Sikaflex 1A polyurethane sealant or Dow

Corning RTV 738 or RTV 739

Kistler-Morse® Test Meter

### CAUTION

**Only use Sikaflex 1A polyurethane sealant or Dow Corning RTV 738 or RTV 739.** Other sealants may contain acetic acid, which is harmful to sensors and electronics.



---

## APPENDIX E. TECHNICAL DRAWINGS

This appendix contains the following technical drawing(s):

**DRAWING NUMBER**  
TI-MC.FM-01

**DRAWING TITLE**  
FM Approved Intrinsically Safe Interconnect Diagram, Microcell™ Sensor

REVISIONS				
LTR	DESCRIPTION	CHECKED	APPROVED	DATE
NEW	Initial Release	S.A.S.	K.P.M.	9/30/91
A	Per ECO #2747	J.M. Pfen	T.K.M.	2-4-92
B	Per ECO #2829	R.M. Callado	K.P.M.	8/5/92
C	Per ECO #2836	J.M. Pfen	K.P.M.	9/8/92
D	Per ECO #2844	J.M. Pfen	K.P.M.	9/28/92
E	Per ECO #2854	J.M. Pfen	K.P.M.	10/1/92
F	Per ECO #2864	C. Blackton	K.P.M.	9/8/96
G	Per ECO #3148B	N.T.O.	T.J.	5/5/97
H	Per ECO #3281	R.M. Callado	C.A.P.	10/6/97

TABLE 1:

FM APPROVED MICROCELL SENSOR MODEL NUMBERS	FM APPROVED MICROCELL SENSOR MODEL NUMBERS
M20 SERIES	JB15 SERIES
M30 SERIES	JB25 SERIES

NOTES: (UNLESS OTHERWISE SPECIFIED)

- NO CHANGES IN THIS DOCUMENT ARE ALLOWED WITHOUT FACTORY MUTUAL APPROVAL.
- FOR FACTORY MUTUAL APPROVAL, INSTALLATION MUST BE IN ACCORDANCE WITH THIS TECHNICAL ILLUSTRATION (TI) DRAWING, TI-0106, AND NEC-1990 ARTICLE 500 AND 501 FOR CLASS I LOCATIONS, ARTICLE 500 AND 502 FOR CLASS II LOCATIONS, OR ARTICLE 500 AND 503 FOR CLASS III LOCATIONS. A CLASS I HAZARDOUS LOCATION REQUIRES CONDUIT SEAL(S) APPROVED FOR THE LOCATION CONDITIONS AND USE. SEE NEC-1990 ARTICLE 500 AND 501.
- ALL INTERCONNECT CABLE SHOWN IS PROVIDED AND INSTALLED BY THE CUSTOMER WHEN USING CONDUIT FOR THE INTERCONNECT CABLE. RUN TO THE NON-HAZARDOUS AREA, ROUTE ONLY THE INTERCONNECT CABLE THROUGH THIS CONDUIT.
- UP TO FOUR MICROCELL SENSOR SIGNAL CABLES CAN BE ACCOMMODATED IN ONE INTERCONNECT JUNCTION BOX. JUNCTION BOXES CAN BE INTERCONNECTED TOGETHER AS REQUIRED. INTERCONNECT JUNCTION BOX COVERS MUST BE ON TIGHT AT ALL TIMES AND UNUSED OPENINGS SEALED WITH THE PROVIDED PLUGS.
- INSTALL 3/4" CONDUIT NUT WITH LIQUID SEALS ON BOTH SIDES OF JUNCTION BOX ENTRY. ACCEPTABLE SOURCES ARE THOMAS & BETTS #42SL, REGAL #802S, OR EQUIVALENT.
- CAUTION: DO NOT APPLY IN EXCESS OF 8 POUND-INCHES OF TORQUE TO JUNCTION BOX COVER SCREWS.
- TO PREVENT MOISTURE ACCUMULATION IN JUNCTION BOX, A DRAIN MUST BE INSTALLED AT A LOWER POINT IN THE CONDUIT (SEE DETAIL C). USE GROUSE-HINDS EGD17 DRAIN OR EQUIVALENT.
- FOR CLASS I AND CLASS II DIVISION 2, GROUPS A-D, F AND G LOCATIONS, INTRINSIC SAFETY BARRIERS MAY BE OMITTED PROVIDED INSTALLATION IS IN COMPLIANCE WITH THE N.E.C. ARTICLES APPLICABLE TO THESE LOCATIONS.

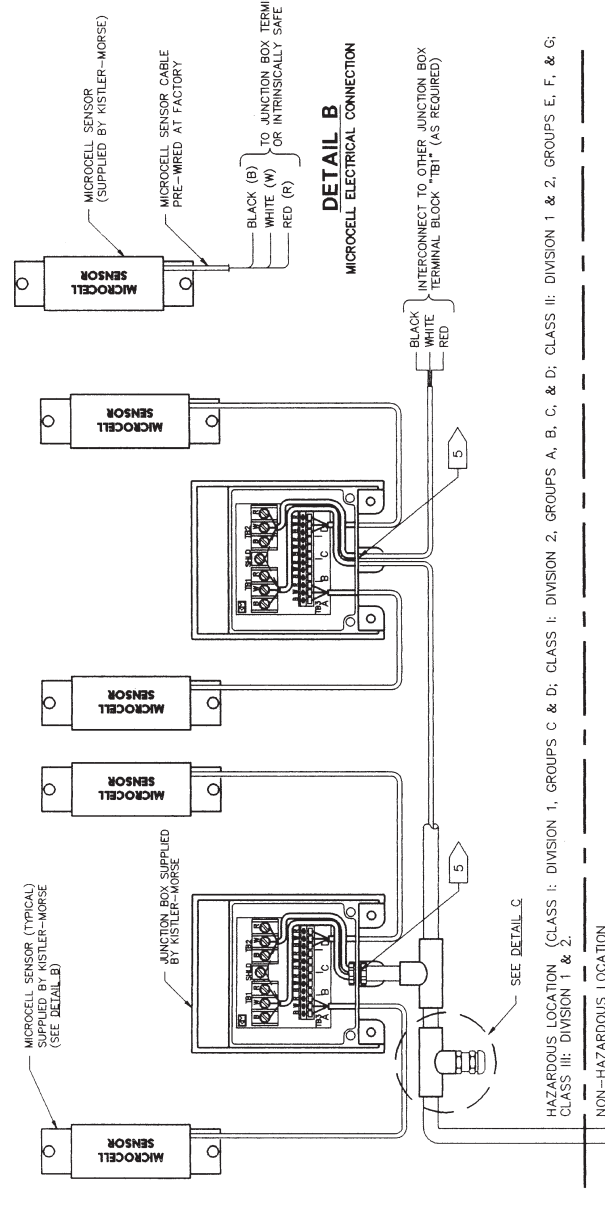

HAZARDOUS LOCATION (CLASS I: DIVISION 1, GROUPS C & D, CLASS II: DIVISION 2, GROUPS A, B, C, & D; CLASS III: DIVISION 1 & 2, GROUPS E, F, & G; NON-HAZARDOUS LOCATION)

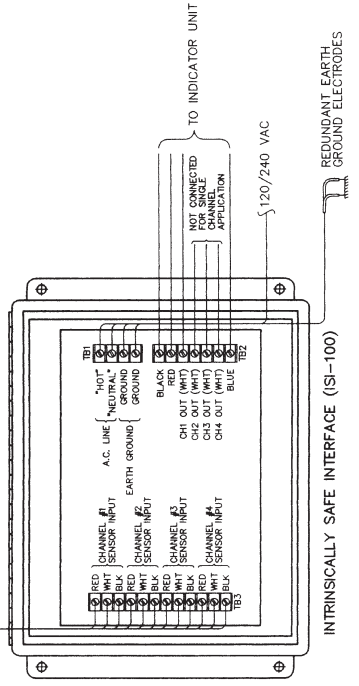
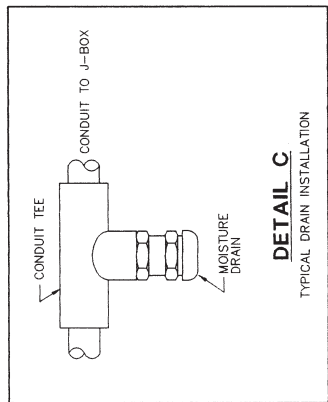

DETAIL A

TYPICAL SENSOR AND JUNCTION-BOX INTERCONNECT WIRING DIAGRAM

ECO ACCUMULATION	APPROVALS	DATE	UNLESS OTHERWISE SPECIFIED DIMENSIONAL TOLERANCES
ECO No. 1	DRAWING: Raul M. Callado	03-27-91	DECIMAL: .03-.27-.91
ECO No. 2	CHECKED: S.A. Smith	09-16-91	ANGULAR: .X2 .X4 .X6 .X8 .X10 .X12 .X15 .X20 .X25 .X30 .X40 .X50 .X60 .X75 .X90 .X100 .X125 .X150 .X200 .X250 .X300 .X400 .X500 .X600 .X750 .X900 .X1000
ECO No. 3	PROJ. ENGR: K.P. Meesteron	03-30-91	DO NOT SCALE DRAWING
ECO No. 4	PRODUCTION:		SCALE: ---
ECO No. 5	PURCHASING:		FINISH: ---
			USED ON: (REF ONLY)

ECO ACCUMULATION	APPROVALS	DATE	UNLESS OTHERWISE SPECIFIED DIMENSIONAL TOLERANCES
ECO No. 1	DRAWING: Raul M. Callado	03-27-91	DECIMAL: .03-.27-.91
ECO No. 2	CHECKED: S.A. Smith	09-16-91	ANGULAR: .X2 .X4 .X6 .X8 .X10 .X12 .X15 .X20 .X25 .X30 .X40 .X50 .X60 .X75 .X90 .X100 .X125 .X150 .X200 .X250 .X300 .X400 .X500 .X600 .X750 .X900 .X1000
ECO No. 3	PROJ. ENGR: K.P. Meesteron	03-30-91	DO NOT SCALE DRAWING
ECO No. 4	PRODUCTION:		SCALE: ---
ECO No. 5	PURCHASING:		FINISH: ---
			USED ON: (REF ONLY)

**Kistler-Morse Corp.**  
**Bethell, WA 98011**

THIS DRAWING IS AN APPROVED INTRINSICALLY SAFE INTERCONNECT DIAGRAM, MICROCELL SENSOR

SIZE DWG. No. **B** | REV. **H**

ACAD. # | MCFMKT | DATE: 10/9/97 | SHT. 1 OF 1

FM CONTROLLED DOCUMENT  
 NO CHANGES TO DRAWING  
 WITHOUT PRIOR FM APPROVAL





150 Venture Boulevard  
Spartanburg, SC 29306  
(800) 426.9010 [Toll Free]  
(864) 574.2763 [Phone]  
(864) 574.8063 [Fax]  
[www.kistlermorse.com](http://www.kistlermorse.com)  
[sales@kistlermorse.com](mailto:sales@kistlermorse.com)

© 2010 Venture Measurement.  
All rights reserved.  
All data subject to change.

97-1012-02  
Revision G  
March 2010